

SDNV143 - Impact of an elastoplastic block by a laser shock modelled by a pressure in dynamics

Summary:

This test makes it possible to validate the order `DYNA_NON_LINE` with a perfectly plastic nonlinear behavior such as `VMIS_ISOT_LINE` with a worthless slope of work hardening. It is about a block subjected to a laser shock modelled by a pressure in dynamics. The reference solution is an analytical result drawn from the thesis of Patrick Ballard [bib1].

Four modelings are used for diagrams in time and different space discretizations:

- Quadratic modeling a: grid and diagram of Newmark (implicit) + `VMIS_ISOT_LINE`
- Quadratic modeling b: grid and diagram of HHT (implicit) + `VMIS_ISOT_LINE`
- Modeling C: linear grid and diagram of HHT (implicit) + `VMIS_ISOT_LINE`
- Modeling D: linear grid and diagram of `DIFF_CENT` (clarifies) + `VMIS_ISOT_LINE`

1 Problem of reference

1.1 Geometry

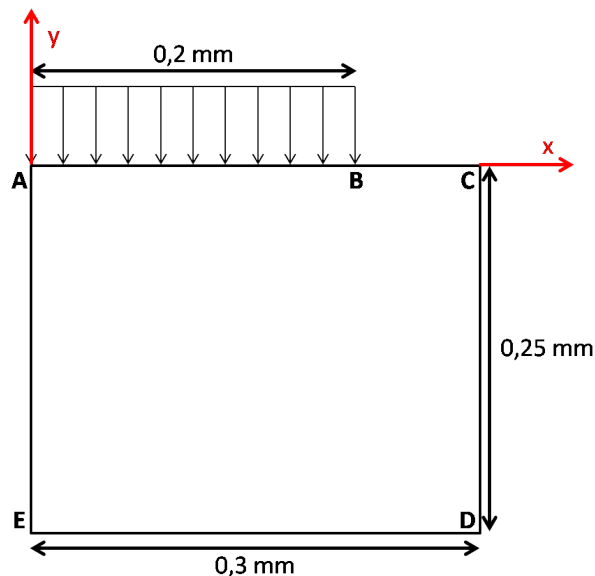

1.2 Material properties

The material considered is a martensitic steel with a behavior élasto-parfaitement plastic.

- Young modulus: $E = 210 \text{ GPa}$
- Poisson's ratio: $\nu = 0.3$
- Elastic limit: $\sigma_Y = 870 \text{ MPa}$
- Density: $\rho = 7500 \text{ kg/m}^3$

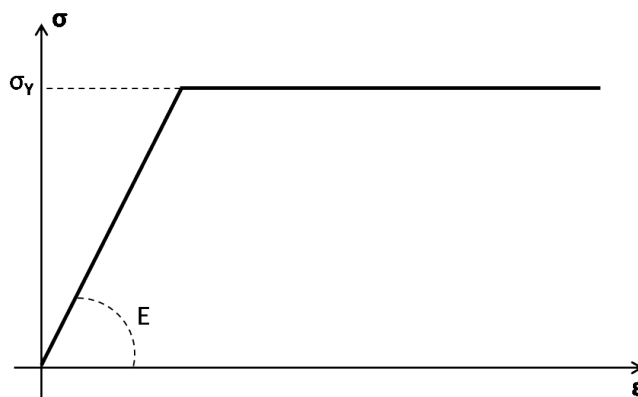

1.3 Boundary conditions and loadings

The model is axisymmetric, consequently, axis AE is blocked according to X. The block is in simple support on bottom, therefore ED is blocked according to Y.

The loading is a pressure crenel in times of 5 GPa applied during 20 NS regularly to a circle diameter 0.4 mm.

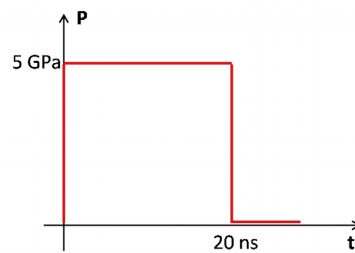

The wave propagation being regarded as plane, we consider that there are no effects edges for a one duration calculation of 22 NS.

2 Reference solution

2.1 Method of calculating used for the reference solution

One considers the analytical model of the laser shock established in 1991 by Patrick Ballard [ref.] for the fast impacts. A fast impact is an impact which observes the condition of uniaxiality of the deformations.

The assumptions retained for analytical calculation are the following ones:

- one places oneself in assumption of the small disturbances (HP),
- the material is élasto-parfaitement plastic, or with kinematic work hardening,
- the heating effects are neglected,
- the deformation is supposed to be uniaxial.

According to the study conducted by Patrick Ballard, various fields depending on the pressure applied and the time of application of the impact exist. In our case, we are in the elastoplastic field.

The uniaxial deformation being supposed, it is written:

$$\underline{\underline{\epsilon}} = \begin{pmatrix} 0 & 0 & 0 \\ 0 & \epsilon_{YY} & 0 \\ 0 & 0 & 0 \end{pmatrix}$$

In the elastoplastic case, the behavior is written:

$$\underline{\underline{\sigma}} = \lambda \cdot Tr(\underline{\underline{\epsilon}}) + 2\mu \cdot (\underline{\underline{\epsilon}} - \underline{\underline{\epsilon}}_P)$$

The plastic deformation being deviatoric, we obtain:

$$\underline{\underline{\epsilon}}_P = \begin{pmatrix} -\frac{\epsilon_P}{2} & 0 & 0 \\ 0 & \epsilon_P & 0 \\ 0 & 0 & \frac{-\epsilon_P}{2} \end{pmatrix}$$

that is to say:

$$\underline{\underline{\sigma}} = \begin{pmatrix} \sigma_{XX} & 0 & 0 \\ 0 & \sigma_{YY} & 0 \\ 0 & 0 & \sigma_{XX} \end{pmatrix}$$

with:

$$\begin{aligned} \sigma_{XX} &= \lambda \cdot \epsilon + \mu \cdot \epsilon_P \\ \sigma_{YY} &= (\lambda + 2 \cdot \mu) \cdot \epsilon - 2 \mu \cdot \epsilon_P \end{aligned}$$

With these equations, it is necessary to add the criterion of plasticity:

$$\begin{aligned} \epsilon_P &= 0 \text{ si } |\sigma_{XX} - \sigma_{YY}| < \sigma_Y \\ |\sigma_{XX} - \sigma_{YY}| &= \sigma_Y \text{ sinon} \end{aligned}$$

By solving the fundamental equation of dynamics:

$$\overrightarrow{div} \underline{\underline{\sigma}} = \rho \ddot{\underline{\underline{u}}}$$

we obtain the differential connections which govern the wave propagation following:

$$\frac{\partial \sigma_{YY}}{\partial y} - \rho \frac{\partial v}{\partial t} = 0$$

$$(\lambda + 2 \cdot \mu) \frac{\partial v}{\partial y} - \frac{\partial \sigma_{YY}}{\partial t} = 0$$

$$si |\sigma_x - \sigma_y| < \sigma_y$$

$$\frac{\partial \sigma_{YY}}{\partial y} - \rho \frac{\partial v}{\partial t} = 0$$

$$\left(\lambda + \frac{2 \cdot \mu}{3}\right) \frac{\partial v}{\partial y} - \frac{\partial \sigma_{YY}}{\partial t} = 0$$

sinon

There thus exist elastic waves and plastics which are propagated at different speeds:

$$c_{elastique} = \sqrt{\frac{\lambda + 2 \cdot \mu}{\rho}} \quad et \quad c_{plastique} = \sqrt{\frac{\lambda + \frac{2 \cdot \mu}{3}}{\rho}}$$

Below, one represents the response of an elastoplastic material to a request crenel in time analyzed by the method of the characteristics, by considering that at the time of the face of rise and descent of the loading crenel, one obtains a line characteristic of slope equal to elastic celerity and a line having a slope equal to plastic celerity.

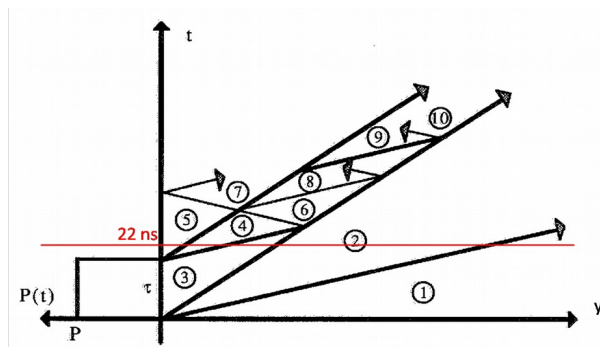

On the way of the characteristic line, the dynamic equation of continuity gives us:

$$[\sigma_{YY}] = -\rho \cdot c \cdot [v]$$

The gross profit of the answer of an elastoplastic material subjected to a pressure P one duration old τ for the first moments is the following:

$$\sigma_1 = 0$$

$$\sigma_2 = -\sigma_Y \cdot \left(1 + \frac{\lambda}{2 \cdot \mu}\right)$$

$$\sigma_3 = -P$$

$$\sigma_4 = -P + 2\sigma_2$$

$$\sigma_5 = 0$$

Thus, for a loading of 5 one duration GPa of 20 NS, the constraints in the depth with 22 NS are the following ones:

- For including between 0 mm and 9,4E-3 mm: $\sigma = 0$
- For including between 9,4E-3 mm and 0.01 mm: $\sigma = -2,06295 \text{ GPa}$
- For including between 0.01 mm and 0.103 mm: $\sigma = -5 \text{ GPa}$
- For including between 0.103 mm and 0.133 mm: $\sigma = -1,46853 \text{ GPa}$

- For including between 0.133 mm and 0.25 mm: $\sigma = 0$

2.2 Uncertainty on the solution

No (analytical solution).

3 Modeling A

3.1 Characteristics of modeling

A modeling is used `AXIS`. For the nonlinear dynamic resolution, one adopts the diagram of `NEWMARK` with the coefficients of `beta=0,25` and `gamma=0,5` with one `FORMULATION=' DEPLACEMENT'`.

3.2 Characteristics of the grid

The grid is quadratic and comprises 6890 meshes `QUAD8`, 513 meshes `SEG3` of edge and 21013 nodes. List of the groups of nodes tested: P1 (0, - 0,03mm, 0), P2 (0, - 0,09mm, 0), P3 (0, - 0,114mm, 0), P4 (0, - 0,122mm, 0)

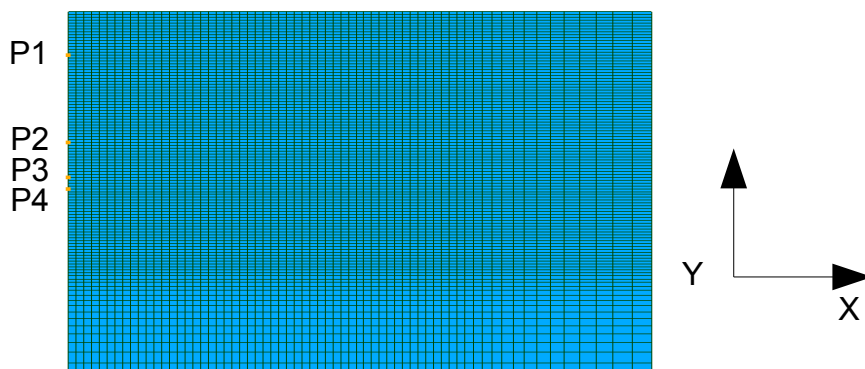

3.3 Sizes tested and results

| Identification | | Moment (10th-9s) | Type of reference | Value of reference | Tolerance (%) |
|----------------|-------------|---------------------|-------------------|-----------------------|------------------|
| Group_NO | Size | | | | |
| <i>P1</i> | <i>SIYY</i> | 22 | 'ANALYTICAL' | -5E9 | 4 |
| <i>P2</i> | <i>SIYY</i> | 22 | 'ANALYTICAL' | -5E9 | 5 |
| <i>P3</i> | <i>SIYY</i> | 22 | 'ANALYTICAL' | -1468526000.0 | 10 |
| <i>P4</i> | <i>SIYY</i> | 22 | 'ANALYTICAL' | -1468526000.0 | 10 |

Time of resolution of the dynamic transient (elapsed time) = 187s (216 iterations of Newton).

Note:

It is possible with the help of a reduction in the step of time to get results even closer to the analytical solution.

4 Modeling B

4.1 Characteristics of modeling

A modeling is used `AXIS`. For the nonlinear dynamic resolution, one adopts the diagram of "HHT" with the coefficients of $\alpha = -0,3$ with `MODI_EQUI = 'YES'` with one `FORMULATION = 'DEPLACEMENT'`.

4.2 Characteristics of the grid

The grid is quadratic and comprises 6890 meshes `QUAD8`, 513 meshes `SEG3` of edge and 21013 nodes.

List of the groups of nodes tested: P1 (0, - 0,03mm, 0), P2 (0, - 0,09mm, 0), P3 (0, - 0,114mm, 0), P4 (0, - 0,122mm, 0).

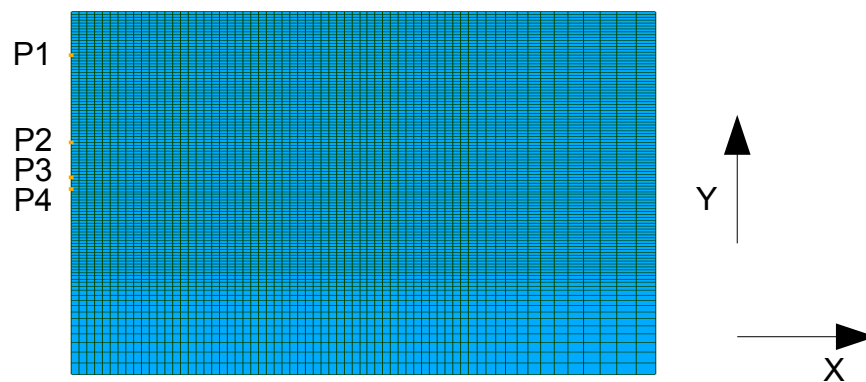

4.3 Sizes tested and results

| Identification | | Moment (10th-9s) | Type of reference | Value of reference | Tolerance (%) |
|----------------|-------------|---------------------|-------------------|-----------------------|------------------|
| Group_NO | Size | | | | |
| <i>P1</i> | <i>SIYY</i> | 22 | 'ANALYTICAL' | -5E9 | 1 |
| <i>P2</i> | <i>SIYY</i> | 22 | 'ANALYTICAL' | -5E9 | 3 |
| <i>P3</i> | <i>SIYY</i> | 22 | 'ANALYTICAL' | -1468526000.0 | 15 |
| <i>P4</i> | <i>SIYY</i> | 22 | 'ANALYTICAL' | -1468526000.0 | 8 |

Time of resolution of the dynamic transient (elapsed time) = 193s (230 iterations of Newton).

Note:

It is possible with the help of a reduction in the step of time to get results even closer to the analytical solution.

5 Modeling C

5.1 Characteristics of modeling

A modeling is used `AXIS`. For the nonlinear dynamic resolution, one adopts the diagram of `HHT` with the coefficients of `alpha=-0,3` with `MODI_EQUI= 'YES'` with one `FORMULATION=' DEPLACEMENT'`.

5.2 Characteristics of the grid

The grid is linear and comprises 6890 meshes `QUAD4`, 513 meshes `SEG2` of edge and 7062 nodes.

List of the groups of nodes tested: `P1 (0, - 0,03mm, 0)`, `P2 (0, - 0,09mm, 0)`, `P3 (0, - 0,114mm, 0)`, `P4 (0, - 0,122mm, 0)`.

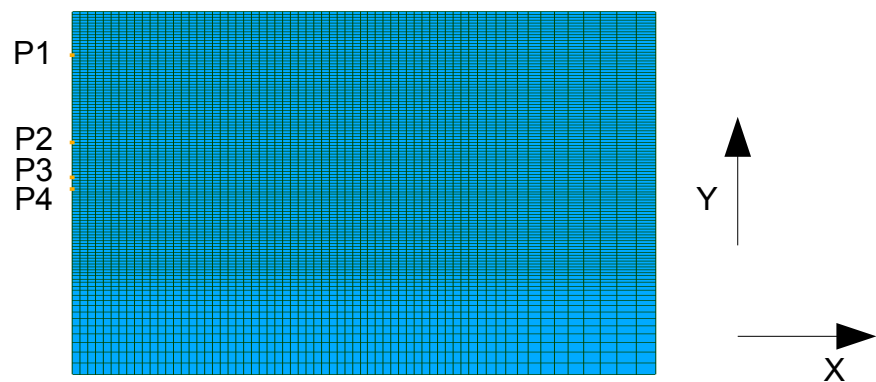

5.3 Sizes tested and results

| Identification | | Moment (10th-9s) | Type of reference | Value of reference | Tolerance (%) |
|----------------|-------------|---------------------|-------------------|-----------------------|------------------|
| Group_NO | Size | | | | |
| <i>P1</i> | <i>SIYY</i> | 22 | 'ANALYTICAL' | -5E9 | 1 |
| <i>P2</i> | <i>SIYY</i> | 22 | 'ANALYTICAL' | -5E9 | 2 |
| <i>P3</i> | <i>SIYY</i> | 22 | 'ANALYTICAL' | -1468526000.0 | 12 |
| <i>P4</i> | <i>SIYY</i> | 22 | 'ANALYTICAL' | -1468526000.0 | 7 |

Time of resolution of the dynamic transient (elapsed time) = 75s (215 iterations of Newton)

Note:

It is possible with the help of a reduction in the step of time to get results even closer to the analytical solution.

6 Modeling D

6.1 Characteristics of modeling

A modeling is used `AXIS`. For the nonlinear dynamic resolution, one adopts the diagram of `DIFF_CENT` with one `FORMULATION='ACCELERATION'`. The step of time was regulated with `1.E-10s`.

6.2 Characteristics of the grid

The grid is linear and comprises 6890 meshes `QUAD8`, 513 meshes `SEG3` of edge and 7062 nodes.

List of the groups of nodes tested: P1 (0, - 0,03mm, 0), P2 (0, - 0,09mm, 0), P3 (0, - 0,114mm, 0), P4 (0, - 0,122mm, 0)

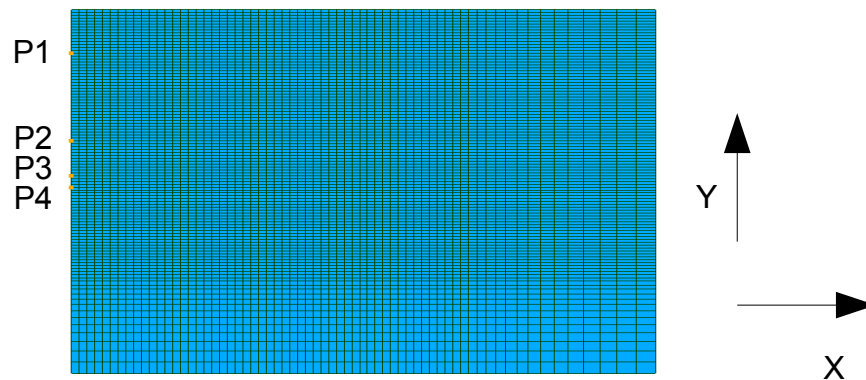

6.3 Sizes tested and results

| Identification | | Moment (10th-9s) | Type of reference | Value of reference | Tolerance (%) |
|----------------|-------------|---------------------|-------------------|-----------------------|------------------|
| Group_NO | Size | | | | |
| <i>P1</i> | <i>SIYY</i> | 22 | 'ANALYTICAL' | -5E9 | 1 |
| <i>P2</i> | <i>SIYY</i> | 22 | 'ANALYTICAL' | -5E9 | 2 |
| <i>P3</i> | <i>SIYY</i> | 22 | 'ANALYTICAL' | -1468526000.0 | 5 |
| <i>P4</i> | <i>SIYY</i> | 22 | 'ANALYTICAL' | -1468526000.0 | 10 |

Time of resolution of the dynamic transient (elapsed time) = 40s.

7 Summary of the results

This test validates the use of the operator of dynamics `DYNA_NON_LINE` with a plastic behavior of type `VMIS_ISOT_LINE`.

The results in constraints are in concord with the analytical solutions on the points close to surface and they are in-depth less good.

It is necessary to raise the influence of the step of time, the grid and the choice of the diagram in time on the quality of the final solution.