

SSLS502 - Orthotropic cylinder subjected to a line of load

Summary:

This test represents quasi-static calculation, of a short orthotropic cylinder and an orthotropic long cylinder subjected to a line of load. At their ends, the cylinders rest on rigid diaphragms. This CAS-test makes it possible to validate modeling finite elements `DST` with meshes `TRIA3` and `QUAD4`, an orthotropic homogeneous material.

Displacements and the efforts obtained are compared with an experimental reference solution like to an analytical solution.

1 Problem of reference

1.1 Geometry

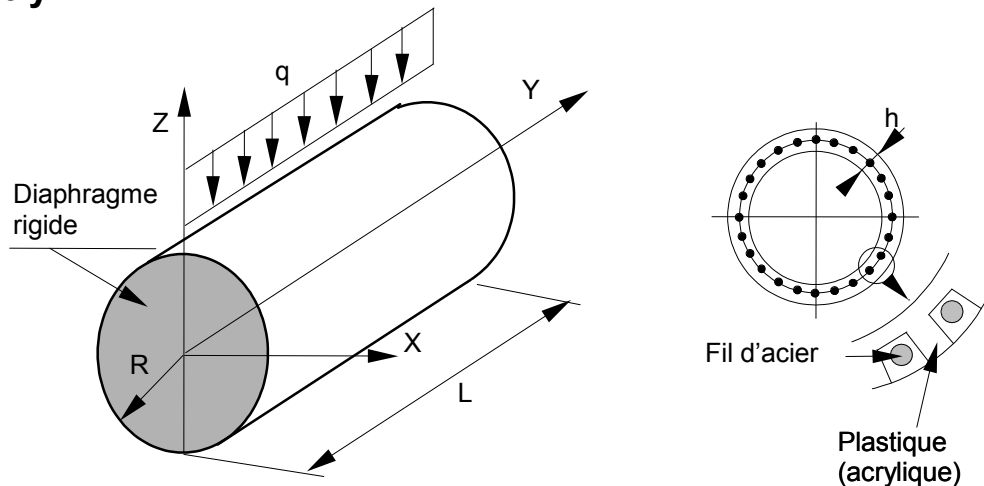

cylindre court :	L = 0.560 m	h = 0.0061 m
	R = 0.13595 m	q = 2357.143 N/m
cylindre long :	L = 2.465 m	h = 0.0061 m
	R = 0.13595 m	q = 896.552 N/m

1.2 Properties of material

The material constituting the cylinder is homogeneous orthotropic. The axes of orthotropism correspond to the curvilinear directions x and y .

$$[H_{membrane}] = h[H] ; [H_{membrane-flexion}] = [0] ; [H_{flexion}] = h^3[H]/12$$

$$H_{11} = 3.0644 \times 10^9 \text{ N/m}^2 ; H_{12} = 1.1048 \times 10^9 \text{ N/m}^2 ; H_{13} = 0$$

$$H_{22} = 18.597 \times 10^9 \text{ N/m}^2 ; H_{23} = 0 ; H_{33} = 1.250 \times 10^9 \text{ N/m}^2$$

1.3 Boundary conditions and loadings

- Boundary conditions: The ends of the cylinder rest on rigid diaphragms
- **Modelings A and B** : Force per unit of length: $q = -2357.143 \text{ N/m}$
- **Modelings C and D** : Force per unit of length: $q = -896.552 \text{ N/m}$

1.4 Initial conditions

Without object

2 Reference solution

2.1 Method of calculating used for the reference solution

We will use for this test two reference solutions, one experimental, resulting from work from Schwaighofer and Microys [bib2], the other drawn from work of Batoz in theory of the deep hulls [bib1].

2.2 Results of reference

The results of reference are the following:

Cylinder runs (A and B)	Batoz [bib1]	Experiment [bib2]
Displacement w at the point F	$0.35 \cdot 10^{-4} m$	$0.6 \cdot 10^{-4} m$
Displacement w at the point C	$-0.7 \cdot 10^{-3} m$	$-0.6 \cdot 10^{-3} m$
Displacement w at the point D	$0.25 \cdot 10^{-4} m$	$0.1 \cdot 10^{-3} m$
Constraint σ_{xx} at the point F	$-0.35 MPa$	$-0.325 MPa$
Constraint σ_{yy} at the point F	$0.50 MPa$	$0.60 MPa$

Long cylinder (C and D)	Batoz [bib1]	Experiment [bib2]
Displacement w at the point F	$1.32 \cdot 10^{-3} m$	$1.35 \cdot 10^{-3} m$
Displacement w at the point C	$-2.45 \cdot 10^{-3} m$	$-2.46 \cdot 10^{-3} m$
Displacement w at the point D	$-0.35 \cdot 10^{-3} m$	$-0.51 \cdot 10^{-3} m$
Constraint σ_{xx} at the point F	$1.68 MPa$	$1.9 MPa$
Constraint σ_{yy} at the point F	$1.8 MPa$	$1.55 MPa$

2.3 Uncertainties on the solution

Approximately 5% with regard to the solution of Batoz, undoubtedly much more – approximately 30% - for the experimental solution.

2.4 Bibliographical references

- 1) BATOZ J.L., DHATT G.: Modeling of the structures by finite elements, Flight 3, Hulls, HERMES.
- 2) SCHWAIGHOFER J., MICROYS H.F.: Orthotropic Cylindrical shells under line load, Newspaper of applied Mechanics, June 1979, Flight 46.
- 3) GEOFFROY P., Development and evaluation of a finite element for the static non-linear analysis and dynamics of thin hulls, Thesis of Doctor Engineer, University of Technology of Compiègne, 4/27/83.

3 Modeling A

3.1 Characteristics of modeling

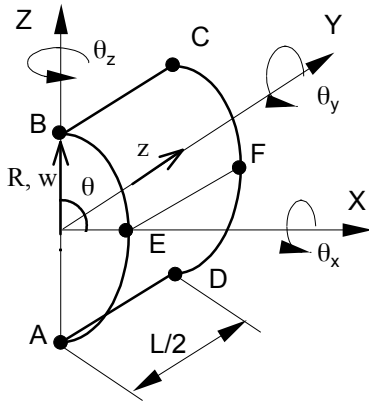

Modélisation DST (on modélise un demi cylindre)

- 8 éléments dans la direction circonférentielle
- 12 éléments dans le sens longitudinal

- Conditions aux limites : Côté AB : $u = w = \theta_y = 0$
- Conditions de symétrie : Côtés AD et BC : $u = \theta_y = \theta_z = 0$
- Côté DC : $v = \theta_x = \theta_z = 0$

- Force par unité de longueur côté BC : $q/2 = -1178.5715 \text{ N/m}$

3.2 Characteristics of the grid

Many nodes: 224
Number of meshes and type: 192 QUAD4

3.3 Values tested

Identification	Digital reference [bib1]	Experimental reference [bib2]	Aster	% differences
Displacement w at the point F	$0.35 \cdot 10^{-4} \text{ m}$	$0.6 \cdot 10^{-4} \text{ m}$	$0.373 \cdot 10^{-4} \text{ m}$	6,703 [bib1] - 37,757 [bib2]
Displacement w at the point C	$-0.71 \cdot 10^{-3} \text{ m}$	$-0.6 \cdot 10^{-3} \text{ m}$	$-0.721 \cdot 10^{-3}$	3,033 [bib1] 20,205 [bib2]
Displacement w at the point D	$0.25 \cdot 10^{-4} \text{ m}$	$0.1 \cdot 10^{-3} \text{ m}$	$0.369 \cdot 10^{-4}$	47,689 [bib1] -63,078 [bib2]
Constraint $SIXX$ at the point F	-0.350 MPa	-0.325 MPa	-0.480 MPa	37,339 [bib1] 47,904 [bib2]
Constraint $SIYY$ at the point F	0.500 MPa	0.600 MPa	0.490 MPa	-1,901 [bib1] -18,259 [bib2]

3.4 Value of normal displacement W along CD

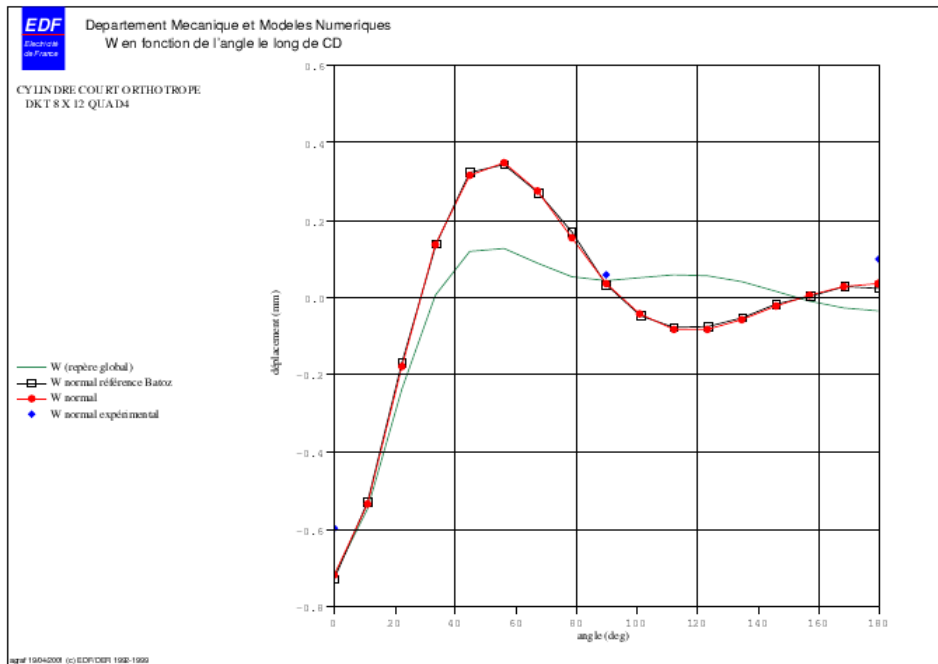

One can note that beyond the variations observed on the points tested C , F , D , the normal displacement calculated along CD is close to the solution in theory “deep hulls” adopted by Batoz [bib1]. One can charge the errors relating to the points F and D with the low value of displacement (about $10^{-5} m$).

3.5 Value of the constraints along CD

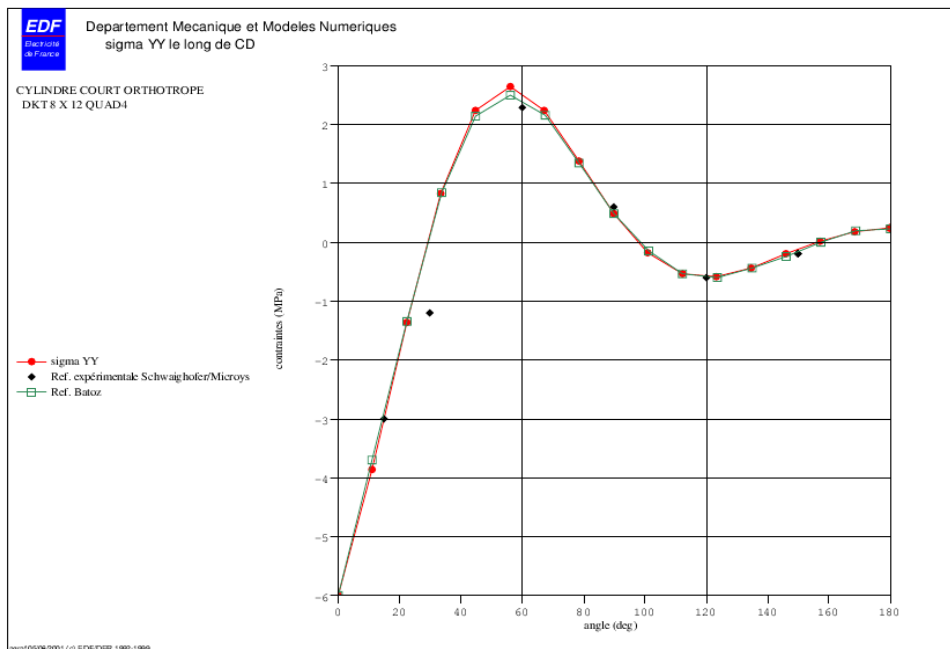
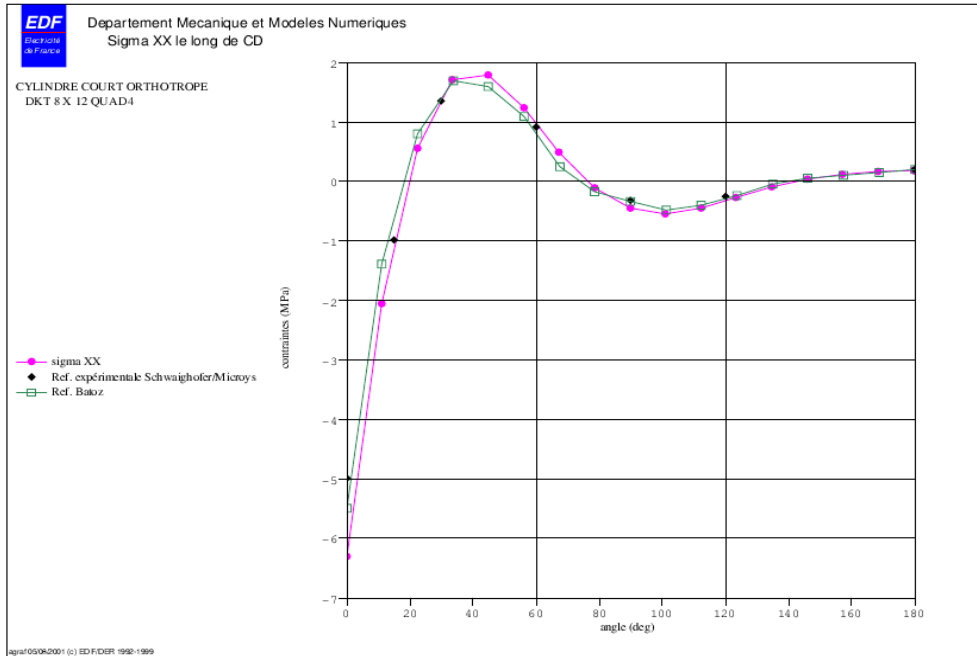

One can note that the constraints calculated along CD are overall in agreement with the solution in theory “deep hulls” adopted by Batoz [bib1].

3.6 Remarks

- Values of the coefficients $CISA_L$ and of $CISA_T$ are not available. As the structure is mean ($h/R=0.045$), it is supposed that the effects of transverse shearing are negligible, we thus imposed $CISA_L=CISA_T= 10^{10}$.
- Displacement w normal (figure of [§4.2]) is expressed in the local cylindrical reference mark (R, θ, z), it is normal displacement to the element of hull. Displacement w tested with [§4.1] as for him is expressed in the total reference mark (following displacement z).

4 Modeling B

4.1 Characteristics of modeling

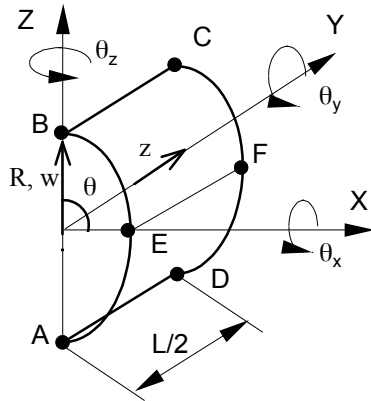

Modélisation DST (on modélise un demi cylindre)

- 8 éléments dans la direction circonférentielle
- 12 éléments dans le sens longitudinal

- Conditions aux limites : Côté AB : $u = w = \theta_y = 0$
- Conditions de symétrie : Côtés AD et BC : $u = \theta_y = \theta_z = 0$
- Côté DC : $v = \theta_x = \theta_z = 0$

- Force par unité de longueur côté BC : $q/2 = -1178.5715 \text{ N/m}$

4.2 Characteristics of the grid

Many nodes: 224
Number of meshes and type: 384 TRIA3

4.3 Values tested

Identification	Reference [bib1]	Reference [bib2]	Aster	% differences
Displacement w at the point F	$0.35 \cdot 10^{-4} \text{ m}$	$0.6 \cdot 10^{-4} \text{ m}$	$0.383 \cdot 10^{-4}$	9,571 [bib1] 36,084 [bib2]
Displacement w at the point C	$-0.71 \cdot 10^{-3} \text{ m}$	$-0.6 \cdot 10^{-3} \text{ m}$	$-7.138 \cdot 10^{-4}$	1,985 [bib1] 18,982 [bib2]
Displacement w at the point D	$0.25 \cdot 10^{-4} \text{ m}$	$0.1 \cdot 10^{-3} \text{ m}$	$0.350 \cdot 10^{-4}$	40,368 [bib1] - 64,908 [bib2]
Constraint S_{IXX} at the point F	-0.350 MPa	-0.325 MPa	-0.470 MPa	34,348 [bib1] 44,682 [bib2]
Constraint S_{IYY} at the point F	0.500 MPa	0.600 MPa	0.400 MPa	- 19,929 [bib1] - 33,274 [bib2]

4.4 Remarks

- Values of the coefficients $CISA_L$ and of $CISA_T$ are not available. As the structure is mean ($h/R=0.045$), it is supposed that the effects of transverse shearing are negligible, we thus imposed $CISA_L=CISA_T= 10^{10}$.

- Displacement W normal is expressed in the local cylindrical reference mark (R, θ, z) , it is normal displacement to the element of hull.

4.5 Value of normal displacement along CD

The results got with a grid TRIA3 are very close to those obtained by grid QUAD4.

4.6 Value of the constraints along CD

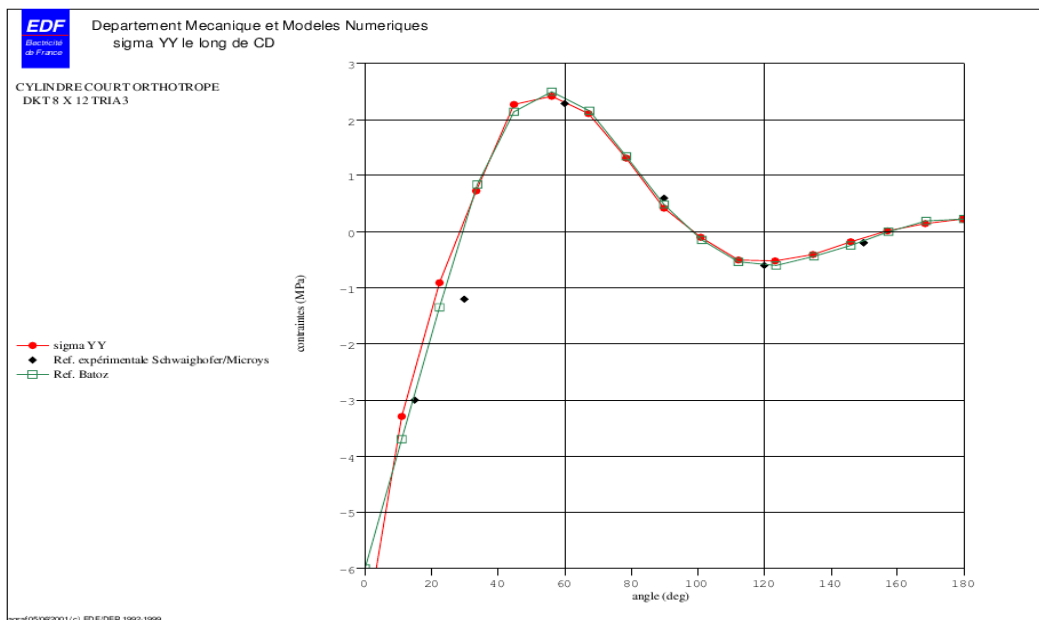
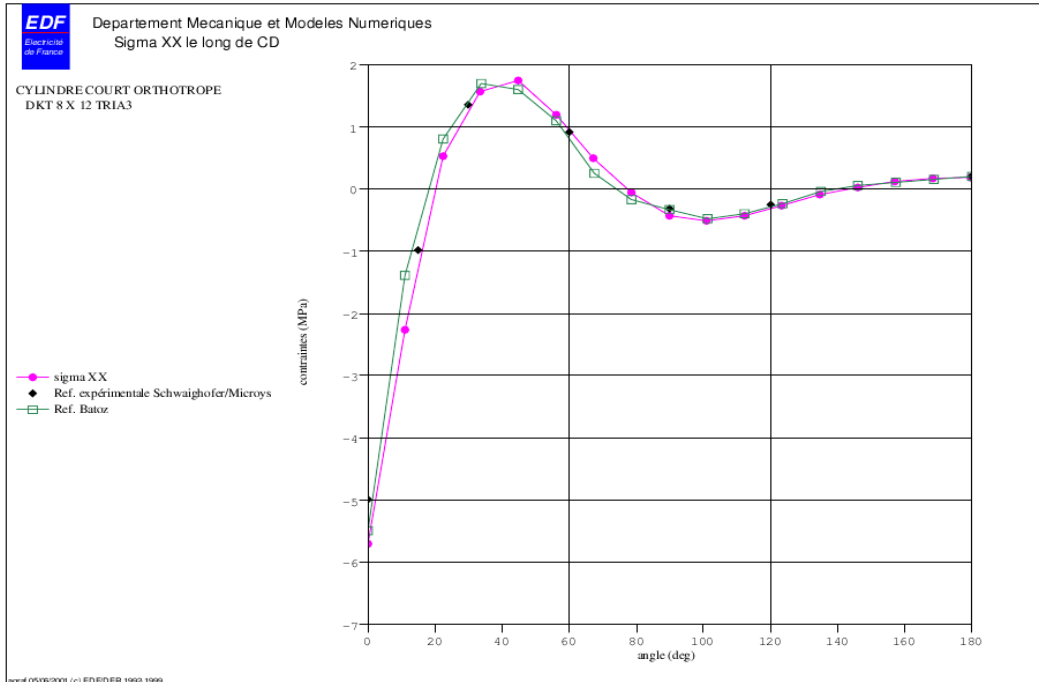

The profiles of the constraints obtained by modeling B with TRIA3 are as a whole close to the solutions of Batoz.

5 Modeling C

5.1 Characteristics of modeling

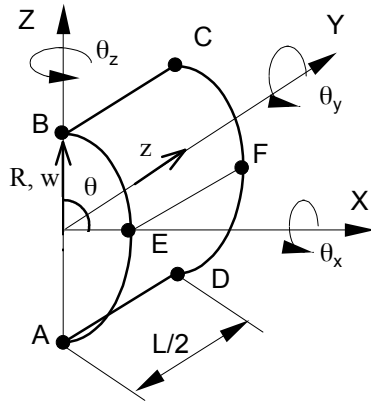

Modélisation DST (on modélise un demi cylindre)

- 8 éléments dans la direction circonférentielle
- 12 éléments dans le sens longitudinal

- Conditions aux limites : Côté AB : $u = w = \theta_y = 0$
- Conditions de symétrie : Côtés AD et BC : $u = \theta_y = \theta_z = 0$
- Côté DC : $v = \theta_x = \theta_z = 0$

- Force par unité de longueur côté BC : $q/2 = -448.276 \text{ N/m}$

5.2 Characteristics of the grid

Many nodes: 224
Number of meshes and type: 384 TRIA3

5.3 Values tested

Identification	Digital reference [bib1]	Experimental reference [bib2]	Aster	% difference
Displacement w at the point F	$1.325 \cdot 10^{-3} \text{ m}$	$1.35 \cdot 10^{-3} \text{ m}$	$1.327 \cdot 10^{-3} \text{ m}$	0,154 [bib1] - [bib2] 1,701
Displacement w at the point C	$-2.45 \cdot 10^{-3} \text{ m}$	$-2.46 \cdot 10^{-3} \text{ m}$	$-2.379 \cdot 10^{-3} \text{ m}$	- [bib1] 2,881 - [bib2] 3,275
Displacement w at the point D	$-0.51 \cdot 10^{-3} \text{ m}$	$-0.35 \cdot 10^{-3} \text{ m}$	$-0.529 \cdot 10^{-3} \text{ m}$	3,859 [bib1] 51,337 [bib2]
Constraint S_{LXX} at the point F	1.68 MPa	1.9 MPa	1.643 MPa	- 2,155 [bib1] - 13,484 [bib2]
Constraint S_{IYY} at the point F	1.8 MPa	1.55 MPa	1.782 MPa	- 0,986 [bib1] - 14,984 [bib2]

5.4 Remarks

- The value of the coefficients $CISA_L$ and of $CISA_T$ are not available. As the structure is mean ($h/R=0.045$), it is supposed that the effects of transverse shearing are negligible, we thus imposed $CISA_L=CISA_T=10^{10}$.
- Displacement w normal is expressed in the local cylindrical reference mark (R, θ, z) , it is normal displacement to the element of hull.

5.5 Value of normal displacement along CD

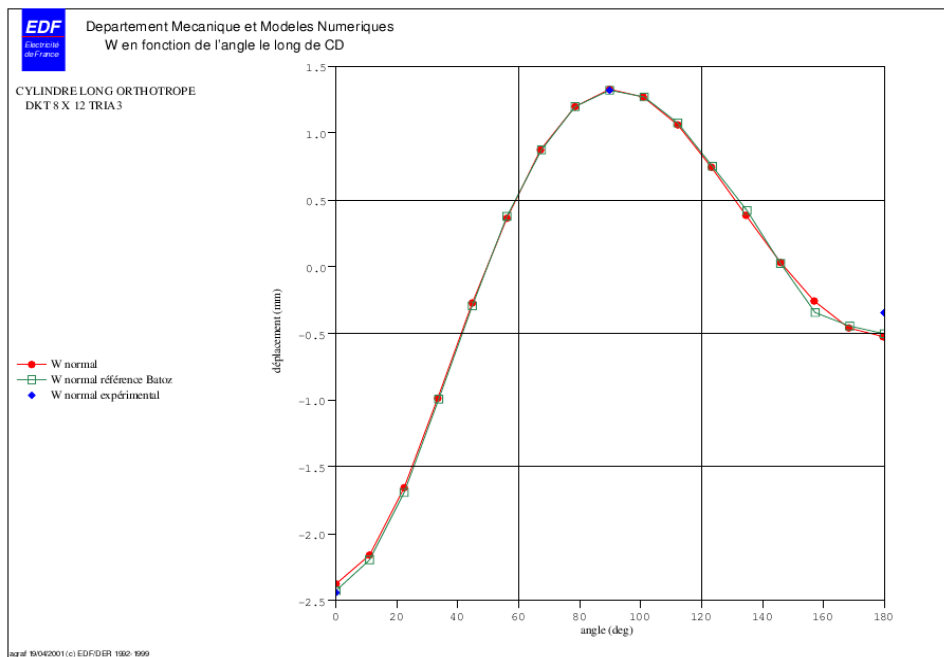

One can note that beyond the variation observed on the experimental value at the point D, the normal displacement calculated along CD is very close to the solution in theory “deep hulls” adopted by Batoz [bib1].

5.6 Value of the constraints along CD

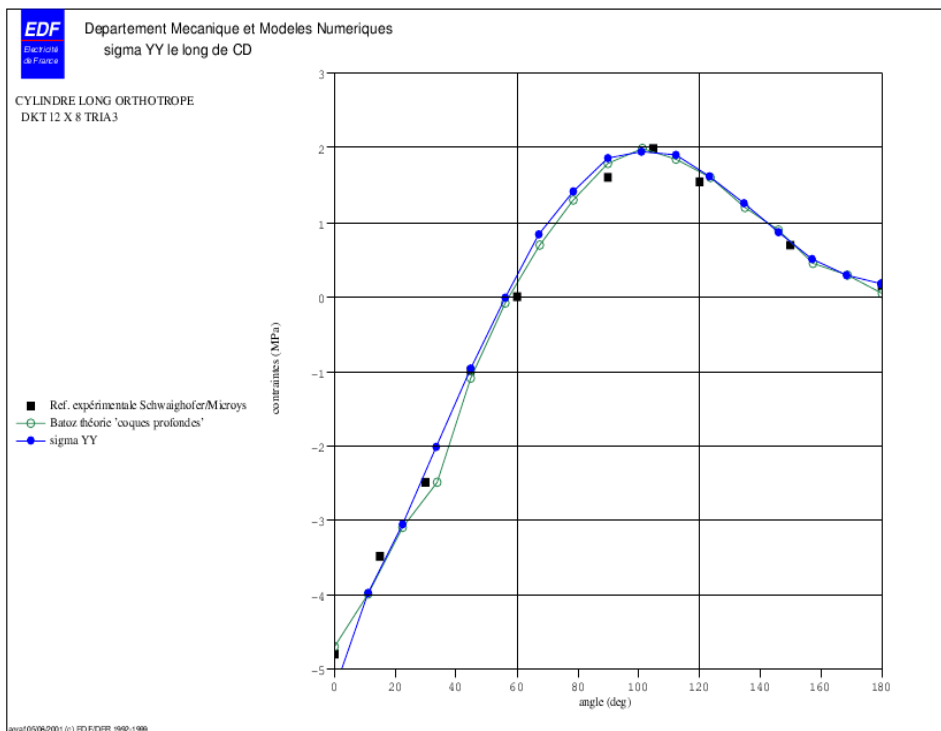
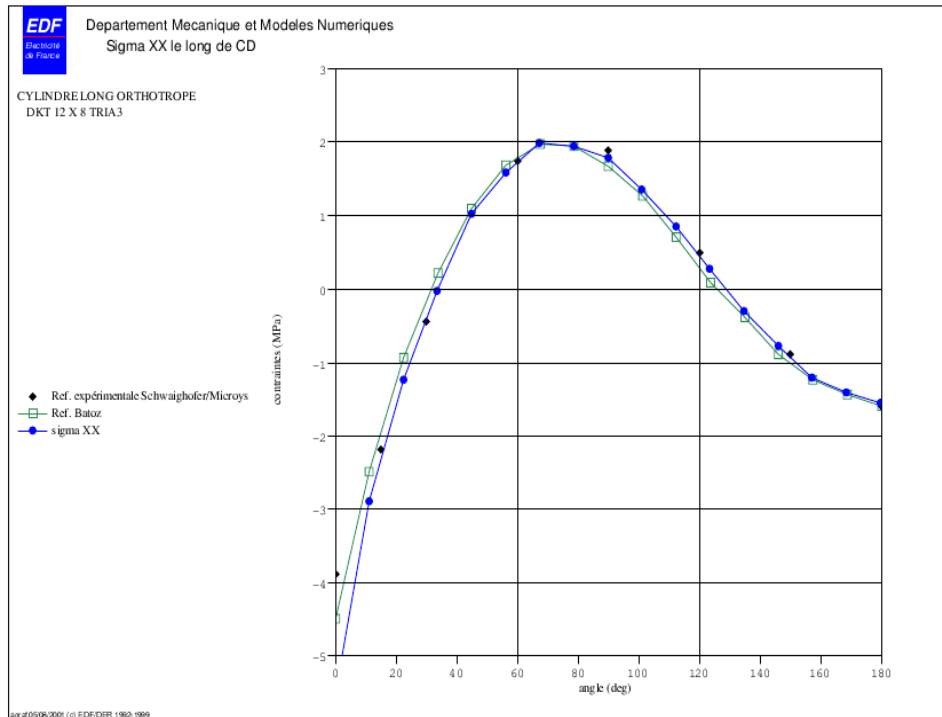

The profiles of the constraints calculated by the code are overall in agreement with work of Batoz.

6 Modeling D

6.1 Characteristics of modeling

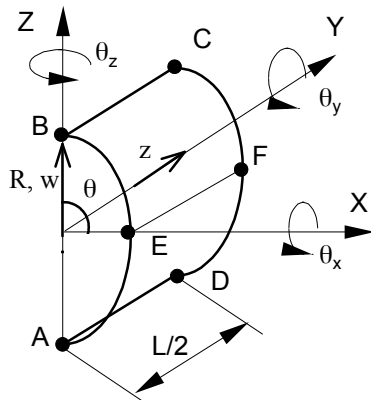

Modélisation DST (on modélise un demi cylindre)

- 8 éléments dans la direction circonférentielle
- 12 éléments dans le sens longitudinal

- Conditions aux limites : Côté AB : $u = w = \theta_y = 0$
- Conditions de symétrie : Côtés AD et BC : $u = \theta_y = \theta_z = 0$
- Côté DC : $v = \theta_x = \theta_z = 0$

- Force par unité de longueur côté BC : $q/2 = -448.276 \text{ N/m}$

6.2 Characteristics of the grid

Many nodes: 224
Number of meshes and type: 192 QUAD4

6.3 Values tested

Identification	Reference [bib1]	Reference [bib2]	Aster	% difference
Displacement w at the point F	$1.325 \cdot 10^{-3} \text{ m}$	$1.35 \cdot 10^{-3} \text{ m}$	$1.329 \cdot 10^{-3} \text{ m}$	0,365 [bib1] - 1,494 [bib2]
Displacement w at the point C	$-2.45 \cdot 10^{-3} \text{ m}$	$-2.46 \cdot 10^{-3} \text{ m}$	$-2.369 \cdot 10^{-3} \text{ m}$	- 3,274 [bib1] - 3,667 [bib2]
Displacement w at the point D	$-0.51 \cdot 10^{-3} \text{ m}$	$-0.35 \cdot 10^{-3} \text{ m}$	$-0.528 \cdot 10^{-3} \text{ m}$	3,634 [bib1] 51,009 [bib2]
Constraint S_{IXX} at the point F	1.68 MPa	1.9 MPa	1.79 MPa	6,616 [bib1] - 5,729 [bib2]
Constraint S_{IYY} at the point F	1.8 MPa	1.55 MPa	1.84 MPa	2,465 [bib1] 18,991 [bib2]

6.4 Remarks

- The value of the coefficients $CISA_L$ and of $CISA_T$ are not available. As the structure is mean ($h/R=0.045$), it is supposed that the effects of transverse shearing are negligible, we thus imposed $CISA_L=CISA_T= 10^{10}$.
- Displacement w normal is expressed in the local cylindrical reference mark (R, θ, z) , it is normal displacement to the element of hull. Displacement w tested is that of the total reference mark (following displacement z).

6.5 Value of displacement along CD

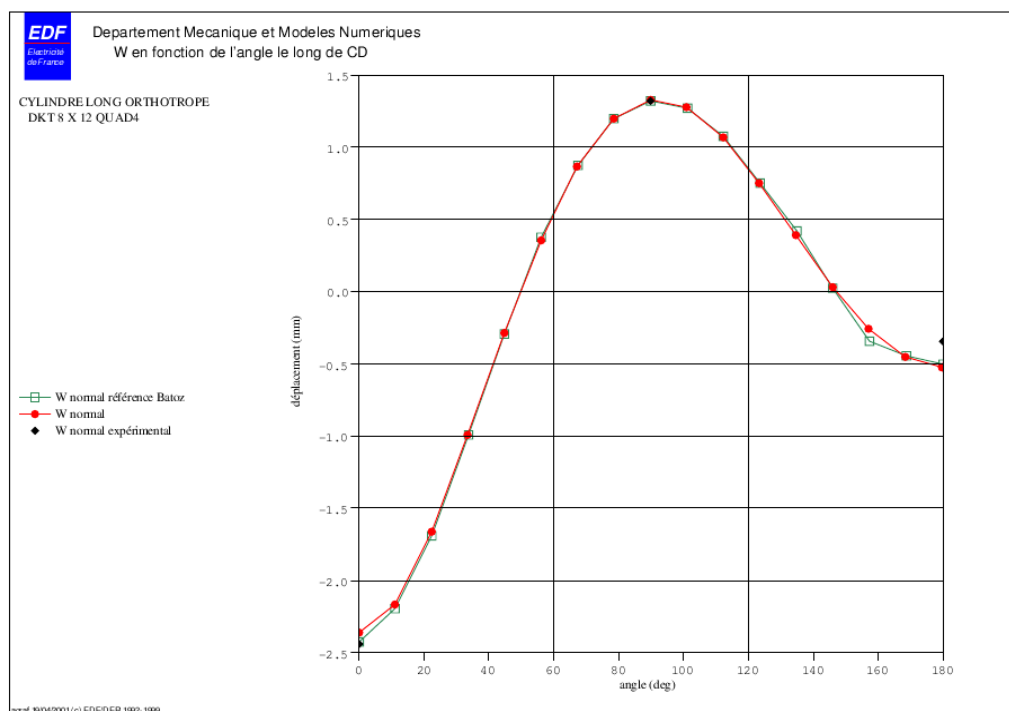

One can note that beyond the variation observed on the experimental value at the point D , the normal displacement calculated along CD is very close to the solution in theory “deep hulls” adopted by Batoz [bib1].

6.6 Values of the constraints along CD

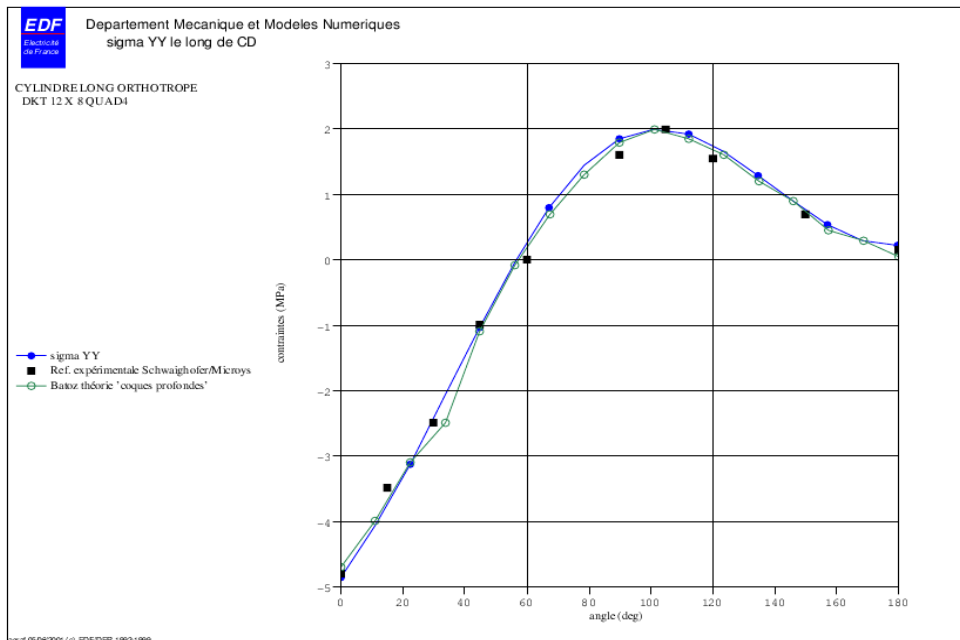
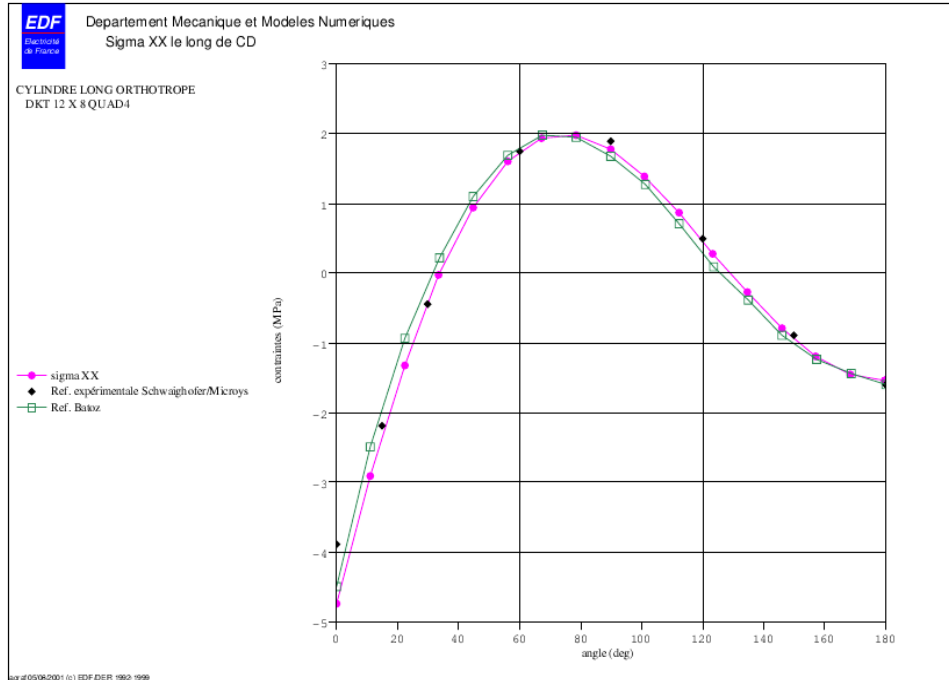

7 Summary of the results

The results are as a whole satisfactory. The specific variations which appear at the points tested, in particular the point D , seem due to the experimental uncertainty, undoubtedly reinforced by an uncertainty as for the graphic taking away.

A contrario, the solutions suggested by Batoz in theory “deep hulls” are well checked by four modelings, with relative errors of less than 5% for the long cylinder.

It appears that:

- modelings TRIA3 and QUAD4 are appreciably equivalent for this problem,
- the relative errors are much weaker for the long cylinder (modelings C and D) than for the short cylinder (modelings A and B): at the point F , the error is reduced of a factor 10 compared to the reference solution of Batoz,
- the refinement of the grid does not minimize in a decisive way the relative variations, as well with the TRIA3 as with the QUAD4.

It is thus noted that the results indeed degrade when the report length on the diameter decreases, the geometrical effects become important with this kind of modeling. It would be desirable to be able to carry out a calculation in finite elements of hulls in orthotropic medium, in order to better take into account the curve, the plates constituting a borderline case.