

Relations of behavior of the discrete elements

Summary:

This document describes the nonlinear behaviors of the discrete elements which are called by the operators of resolution of nonlinear problems `STAT_NON_LINE` or `DYNA_NON_LINE`.

More precisely, the behaviors described in this document are:

- the behavior of the type Von-Put at isotropic work hardening used for the modeling of the threaded assemblies, accessible by the keywords `DIS_GOUJ2E_PLAS` and `DIS_GOUJ2E_ELAS` keyword `BEHAVIOR`,
- the behavior of type contact with shock and friction of Coulomb, accessible by the keyword `DIS_CHOC` keyword `BEHAVIOR`,
- the behavior of the type Von-Put at kinematic work hardening nonlinear, accessible by the keyword `DIS_ECRO_CINE`,
- the viscoelastic behavior rheological nonlinear, accessible by the keyword `DIS_VISC`,
- the behavior non-linear, accessible by the keyword `DIS_ECRO_TRAC`,
- the elastic behavior bilinear, accessible by the keyword `DIS_BILI_ELAS`,
- the behavior of type unilateral contact with friction of Coulomb, used to model behaviour in translation and rotation of the whole within the competences of connection grid-pencil of the adzemplages combustible, accessible by the keyword `DIS_GRICRA`.
- the behavior of conductor arrangement, accessible by the keyword `WEAPON` ,

The integration of the models of behavior mentioned above is detailed in this document. Other behaviors relating to the discrete elements are available, but nonhere detailed:

- Nonlinear assembly of angles of pylons (Relation `ASSE_CORN`) [R5.03.32].

Contents

1	Principles generals of the relations of behavior of the discrete elements.....	4
1.1	Nonlinear relations of behavior (of the discrete elements).....	4
1.2	Calculation of the deformations (small deformations).....	5
1.3	Calculation of the efforts and the nodal forces.....	6
1.4	General notations.....	6
2	Relation of behaviour of the threaded assemblies.....	7
2.1	Equations of the model DIS_GOUJ2E_PLAS.....	7
2.2	Integration of the relation DIS_GOUJ2E_PLAS.....	7
2.3	Internal variables.....	8
3	Bilinear elastic behavior: DIS_BILI_ELAS.....	9
3.1	Definition.....	9
3.2	Internal variables.....	9
4	Behavior DIS_ECRO_CINE.....	10
4.1	Definition.....	10
4.2	Integration of the behavior.....	10
4.3	Internal variables.....	11
5	Nonlinear viscoelastic behavior DIS_VISC.....	12
5.1	Definition.....	12
5.2	Formulation of the behavior.....	13
5.3	Setting in data.....	14
5.4	Integration of the behavior.....	15
5.5	Internal variables.....	16
6	Non-linear behavior DIS_ECRO_TRAC.....	17
6.1	Definition.....	17
6.2	Setting in data.....	17
6.3	Formulation of the behavior.....	17
6.4	Local integration of the behavior.....	18
6.5	Internal variables.....	18
7	Modeling of the shocks and friction: DIS_CHOC.....	19
7.1	Relation of unilateral contact.....	19
7.2	Law of friction of Coulomb.....	20
7.3	Approximate modeling of the relations of contact by penalization.....	21
7.4	Definition of the parameters of contact.....	23
8	Modeling of the connection grid-pencil: DIS_GRICRA.....	24
8.1	General presentation.....	24
8.2	Definition of the local reference mark.....	25
8.3	Behavior in translation.....	26
8.4	Behaviour in rotation.....	27

8.5 Notice.....	29
8.6 Use.....	30
9 Behavior WEAPON.....	32
9.1 Definition.....	32
9.2 Internal variables.....	33
10 Bibliography.....	34
11 History of the versions of the document.....	34

1 Principles generals of the relations of behavior of the discrete elements

1.1 Nonlinear relations of behavior (of the discrete elements)

Relations available in *Code_Aster* for the discrete elements are incremental relations of behavior given under the keyword `factor BEHAVIOR` by the keyword `RELATION` in the nonlinear operators `STAT_NON_LINE` and `DYNA_NON_LINE`. One distinguishes:

- the behavior of the type Von-Put at isotropic work hardening used for the modeling of the threaded assemblies, implemented in `MACR_GOUJ2E_CALC` and accessible by the keywords `DIS_GOUJ2E_PLAS` and `DIS_GOUJ2E_ELAS`,
- the behavior of type contact with shock and friction of Coulomb, accessible by the keyword `DIS_CHOC`,
- the behavior of the type Von Mises to kinematic work hardening nonlinear, accessible by the keyword `DIS_ECRO_CINE`,
- the viscoelastic behavior linear, accessible by the keyword `DIS_VISC`,
- the behavior non-linear, accessible by the keyword `DIS_ECRO_TRAC`,
- the elastic behavior bilinear, accessible by the keyword `DIS_BILI_ELAS`,
- the behavior of type unilateral contact with friction of Coulomb, used to model behaviour in translation and rotation of the whole within the competences of connection roasts – pencil of the fuel assemblies, accessible by the keyword `DIS_GRICRA`,
- the behavior of conductor arrangement, accessible by the keyword `WEAPON` ,

And the following behaviors, which are not here detailed:

- Nonlinear assembly of angles of pylons (relation `ASSE_CORN`) [R5.03.32],

The parameters necessary to these relations are provided in the operator `DEFI_MATERIAU` by the keywords:

Behavior in <code>STAT_NON_LINE</code> <code>DYNA_NON_LINE</code>	Type of element (modeling) in <code>AFFE_MODELE</code>	Keywords in <code>DEFI_MATERIAU</code>	<code>AFFE_CARA_ELEM</code> keywords under <code>DISCRETE</code>
<code>DIS_GOUJ2E_ELAS</code> <code>DIS_GOUJ2E_PLAS</code>	<code>2D_DIS_T</code> : discrete element 2D with two nodes in translation	<code>TRACTION</code>	<code>CARA: 'K_T_D_L'</code>
<code>DIS_ECRO_CINE</code>	<code>DIS_T, D_DIS_T,</code> <code>DIS_TR, 2D_DIS_TR</code> : discrete elements 2D or 3D with one or two nodes in translation/rotation	<code>DIS_ECRO_CINE</code>	<code>CARA: 'K_T_D_L'</code> <code>CARA: 'K_TR_D_L'</code> <code>CARA: 'K_T_D_N'</code> <code>CARA: 'K_TR_D_N'</code>
<code>DIS_VISC</code>	<code>DIS_T, 2D_DIS_T,</code> <code>DIS_TR, 2D_DIS_TR</code> : discrete elements 2D or 3D with one or two nodes in translation/rotation	<code>DIS_VISC</code>	<code>CARA: 'K_T_D_L'</code> <code>CARA: 'K_TR_D_L'</code> <code>CARA: 'K_T_D_N'</code> <code>CARA: 'K_TR_D_N'</code>
<code>DIS_BILI_ELAS</code>	<code>DIS_T, 2D_DIS_T,</code> <code>DIS_TR, 2D_DIS_TR</code> : discrete elements 2D or 3D with one or two nodes in translation/rotation	<code>DIS_BILI_ELAS</code>	<code>CARA: 'K_T_D_L'</code> <code>CARA: 'K_TR_D_L'</code> <code>CARA: 'K_T_D_N'</code> <code>CARA: 'K_TR_D_N'</code>
<code>DIS_CHOC</code> contact and shock with friction of Coulomb	<code>DIS_T, 2D_DIS_T</code> : discrete elements 2D or 3D with two nodes in translation.	<code>DIS_CONTACT</code>	<code>CARA: 'K_T_D_L'</code> <code>CARA: 'K_T_D_N'</code> For the calculation of rigidity elastic and clean modes
<code>DIS_GRICRA</code>	<code>DIS_TR</code> : discrete elements 3D with two nodes in translation/rotation	<code>DIS_GRICRA</code>	<code>CARA: 'K_TR_L'</code> For the calculation of rigidity elastic and clean modes
<code>DIS_ECRO_TRAC</code>	<code>DIS_T, DIS_TR</code> : discrete elements 3D with one or two nodes in translation/rotation.	<code>DIS_ECRO_TRAC</code>	<code>CARA: 'K_T_D_L'</code> <code>CARA: 'K_T_D_N'</code> For the calculation of rigidity elastic and clean modes.
<code>WEAPON</code>	<code>DIS_TR</code> : discrete elements 3D with two nodes in translation/rotation	<code>WEAPON</code>	<code>CARA: 'K_TR_L'</code> For the calculation of rigidity elastic and clean modes

Contrary to the models of behavior 1D [bib3], these relations directly bind the efforts and displacements, instead of being formulated between constraints and deformations. They are valid only in small deformations. One describes for each relation of behavior the calculation of the field of efforts starting from an increment of displacement given (cf algorithm of Newton [R5.03.01]), the calculation of the forces nodal R and of the tangent matrix.

1.2 Calculation of the deformations (small deformations)

For each finite element of *Code_Aster*, in `STAT_NON_LINE`, the total algorithm (Newton) provides to the elementary routine, which integrates the behavior, an increase in the field of displacement [R5.03.01]

For the discrete elements with 2 nodes, one from of deduced the increase in elongation (in translation) or rotation, between nodes 1 and 2 of the element: $\Delta \varepsilon = \Delta u_2 - \Delta u_1$.

For the discrete elements with a node, one obtains simply: $\Delta \varepsilon = \Delta u_1$

1.3 Calculation of the efforts and the nodal forces

For integration of the behavior, it is necessary to provide to the total algorithm (Newton) a vector containing the generalized efforts, on the one hand, and on the other hand a vector containing the nodal forces R [R5.03.01] in total reference mark (X, Y, Z) .

For the discrete elements, the resolution of the nonlinear local problem directly provides the efforts in the element (uniforms in the element), in local reference mark (x, y, z) , which is form:

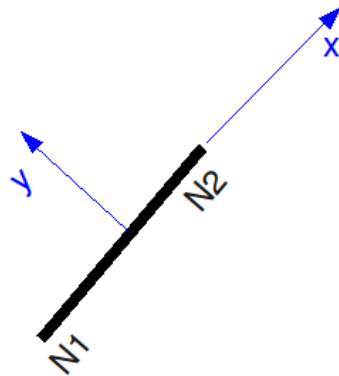

$$F = \begin{pmatrix} F_1(\text{noeud } 1) \\ F_2(\text{noeud } 2) \end{pmatrix} \text{ with } \begin{matrix} \text{in 2D: } F_1 = F_2 = \begin{pmatrix} F_x \\ F_y \end{pmatrix} \\ \text{in 3D: } F_1 = F_2 = \begin{pmatrix} F_x \\ F_y \\ F_z \end{pmatrix} \text{ in translation alone,} \end{matrix}$$

$$F_1 = F_2 = (F_x \quad F_y \quad F_z \quad M_x \quad M_y \quad M_z) \text{ in translation and rotation.}$$

The vector R equivalent nodal forces (which is expressed in the total reference mark) is deduced from F by change of reference mark:

$$R = P^T R_{loc} P \text{ avec } R_{loc} = \begin{pmatrix} -F_1(\text{noeud } 1) \\ F_2(\text{noeud } 2) \end{pmatrix}$$

where P is the matrix of change of reference mark, allowing the passage of the total reference mark towards the local reference mark, as for the elements of beam [R3.08.01].

1.4 General notations

All the quantities evaluated at the previous moment are subscripted by $-$.

Quantities evaluated at the moment $t + \Delta t$ are not subscripted.

The increments are indicated by Δ . One has as follows:

$$Q = Q(t + \Delta t) = Q^-(t) + \Delta Q(t) = Q^- + \Delta Q$$

2 Relation of behaviour of the threaded assemblies

2.1 Equations of the model DIS_GOUJ2E_PLAS

They are deduced from the behavior 3D VMIS_ISOT_TRAC [R5.03.02]: one represents there a relation of behavior of the elastoplastic type to isotropic work hardening, binding the efforts in the discrete element unlike displacement of the two nodes in the direction y local.

In the direction x local, the behavior is elastic, linear, and the coefficient connecting the effort F_x with displacement Dx is the stiffness K_x provided via AFFE_CARA_ELEM.

The nonlinear behavior relates to only the direction y local.

While noting $\Delta \varepsilon = \Delta u_y^1 - \Delta u_y^2$ and $\sigma = F_y^1 = F_y^2$.

The relations are written in the same form as the relations of Von-Put 1D [R5.03.09]:

$$\begin{aligned}\dot{e}^p &= \dot{p} \frac{s}{|s|} \\ s &= E(e - e^p) \\ s_{eq} - R(p) &= |s| - R(p) \leq 0 \\ s_{eq} - R(p) < 0 &\Rightarrow \dot{p} = 0 \\ s_{eq} - R(p) = 0 &\Rightarrow \dot{p}^3 = 0\end{aligned}$$

In these expressions, p represents a "cumulated plastic displacement", and the isotropic function of work hardening $R(p)$ is closely connected per pieces, data in the form of a curved effort – displacement defined point by point, provided under the keyword factor TRACTION of the operator DEFI_MATERIAU [U4.43.01].

The first point corresponds at the end of the linear field, and is thus used to define at the same time the limit of linearity (similar to the elastic limit), and E who is the slope of this linear part (E is independent of the temperature). The function $R(p)$ is deduced from a curve characteristic of the assembly (modeling of some nets) expressing the effort on the pin according to the difference in average displacement between the pin and the support [bib1]: $F = f(u - v)$.

2.2 Integration of the relation DIS_GOUJ2E_PLAS

By Ddirect implicit iscretisation of the relations of behavior, in a way similar to integration 1D [R5.03.09] one obtains:

$$\begin{aligned}E \Delta \varepsilon - \Delta \sigma &= E \Delta p \frac{\sigma^- + \Delta \sigma}{|\sigma^- + \Delta \sigma|} \\ |\sigma^- + \Delta \sigma| - R(p^- + \Delta p) &\leq 0 \\ |\sigma^- + \Delta \sigma| - R(p^- + \Delta p) < 0 &\Rightarrow \Delta p = 0 \\ |\sigma^- + \Delta \sigma| - R(p^- + \Delta p) = 0 &\Rightarrow \Delta p \geq 0\end{aligned}$$

Two cases arise:

- $|\sigma^- + \Delta \sigma| < R(p^- + \Delta p)$ then $\Delta p = 0$ that is to say $\Delta \sigma = E \Delta \varepsilon$ thus $|\sigma^- + E \Delta \varepsilon| < R(p^-)$
- $|\sigma^- + \Delta \sigma| = R(p^- + \Delta p)$ then $\Delta p \geq 0$ thus $|\sigma^- + E \Delta \varepsilon| \geq R(p^-)$

One from of deduced the algorithm from resolution:

let us pose $\sigma^e = \sigma^- + E \Delta \varepsilon$

if $|\sigma^e| \leq R(p^-)$ then $\Delta p = 0$ and $\Delta \sigma = E \Delta \varepsilon$

if $|\sigma^e| > R(p^-)$ then it is necessary to solve:

$$\sigma^e = \sigma^- + \Delta \sigma + E \Delta p \frac{\sigma^- + \Delta \sigma}{|\sigma^- + \Delta \sigma|}$$

$$\sigma^e = (\sigma^- + \Delta \sigma) \left(1 + \frac{E \Delta p}{|\sigma^- + \Delta \sigma|} \right)$$

thus by taking the absolute value:

$$|\sigma^e| = |\sigma^- + \Delta \sigma| \left(1 + \frac{E \Delta p}{|\sigma^- + \Delta \sigma|} \right)$$

maybe, while using $|\sigma^- + \Delta \sigma| = R(p^- + \Delta p)$

$$|\sigma^e| = R(p^- + \Delta p) + E \Delta p$$

By taking account of the linearity per pieces of $R(p)$, one can explicitly solve this equation to find Δp

One from of deduced : $\frac{\sigma^e}{|\sigma^e|} = \frac{\sigma}{R(p^- + \Delta p)}$

then: $\sigma = \sigma^- + \Delta \sigma = \frac{\sigma^e}{|\sigma^e|} R(p) = \frac{\sigma^e}{1 + \frac{E \Delta p}{R(p)}}$

Moreover, the option `FULL_MECA` allows to calculate the tangent matrix \mathbf{K}_i^n with each iteration. The tangent operator who is used for building it is calculated directly on the preceding discretized system. One obtains directly:

- If $|\sigma^e| > R(p^-)$ then $\frac{\delta \sigma}{\delta \epsilon} = E_t = \frac{E R'(p)}{E + R'(p)}$
- if not $\frac{\delta \sigma}{\delta \epsilon} = E$

2.3 Internal variables

The relation of behavior `DIS_GOUJ2E_PLAS` product two internal variables: "cumulated plastic displacement" p , and a being worth indicator 1 if the increase in plastic deformation is nonnull and 0 in the contrary case.

3 Bilinear elastic behavior: DIS_BILI_ELAS

3.1 Definition

The behavior `DIS_BILI_ELAS` is used to model a bilinear elastic behavior in translation, in each direction. The law of behavior was conceived to be used with all the discrete elements. The behavior is characterized by 2 slopes (`KDEB` and `KFIN`) and by effort (`FPRE`) who defines the change of incline.

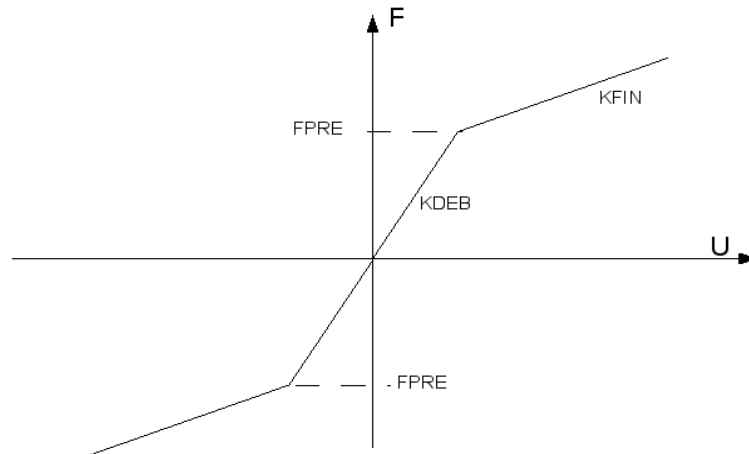

Figure 3.1-a : Bilinear elastic behavior

For this law and that whatever the degree of freedom considered, the behavior of discrete is either elastic or rubber band-bilinear. So in one of the directions the bilinear behavior is not defined, the behavior in this direction is then elastic and they are the values given in the order `AFFE_CARA_ELEM` who are taken. The law `DIS_BILI_ELAS` relate to only the degrees of translation, that thus implies that the behavior is elastic for the degrees of freedom of rotation which exist for this discrete. This local reference mark is defined in a classical way in the order `AFFE_CARA_ELEM` under the key word factor `ORIENTATION`.

3 characteristics (`KDEB`, `KFIN`, `FPRE`) are obligatorily given in the local reference mark of the element, it is thus necessary in the order `AFFE_CARA_ELEM` under the key word factor `DISCRETE` to specify `LOCAL_REPERE=''`. A fatal error is emitted by `Code_Aster` if this condition is not observed.

Sizes `KDEB` and `KFIN` are functions which depend on the temperature and can be defined in the form of function, of tablecloth or formula.

The incremental equations of the law of behavior are simply:

$$\text{If } |F| \leq FPRE \Rightarrow dF = KDEB \cdot dU \quad \text{If not } dF = KFIN \cdot dU$$

F being effort at the moment t considered in one of the directions of translation, and dU the increment of displacement of translation in this direction.

3.2 Internal variables

There is an internal variable per degree of freedom of translation. It can take 3 values:

- $VI=0$, the discrete one was never requested in this direction.
- $VI=1$, one is if $|F| \leq FPRE$
- $VI=2$, one is if $|F| > FPRE$

4 Behavior DIS_ECRO_CINE

4.1 Definition

The behavior DIS_ECRO_CINE is Uelastoplastic law of behaviour to nonlinear kinematic work hardening for discrete elements. This law is defined for each component of the torque of the resulting efforts. The coefficients material are provided under the keyword DIS_ECRO_CINE.

For example for the direction X :

- LIMY_DX : F_e Effort limits elastic along the local axis x element
- KCIN_DX : k_r Stiffness along the local axis x element
- PUIS_DX : n Coefficient of non-linearity along the local axis x element (higher than 1)
- LIMU_DX : F_u Effort limits along the local axis x element.
 - Threshold: $f = |F - X| - F_e$
 - If $f \leq 0$ the behavior is elastic $\dot{F} = K_e \cdot \dot{U}$
 - If not:

$$f = 0 \text{ et } \dot{f} = 0$$

$$\dot{U}^{an} = \dot{\lambda} \frac{\partial f}{\partial F} \quad -\dot{\alpha} = \dot{\lambda} \frac{\partial f}{\partial X} \quad [\text{éq 4.1-1}]$$

$$\dot{F} = K_e (\dot{U} - \dot{U}^{an}) \quad [\text{éq 4.1-2}]$$

$$X = \frac{k_r \alpha}{\left(1 + \left(\frac{k_r \alpha}{F_u}\right)^n\right)^{\frac{1}{n}}} \quad [\text{éq 4.1-3}]$$

4.2 Integration of the behavior

The resolution is obtained after discretization in time in the following way:

$\Delta F = K_e (\Delta U - \Delta U^{an})$ where $\Delta F, \Delta U$ can represent either of the efforts and the translations, or of the moments and rotations.

While calculating: $F^- = K_e (U^- - U_{an}^-)$, an elastic test is carried out:

$$\text{if } |F^- + K_e (\Delta U) - X^-| \leq 0 \text{ then } \Delta F = K_e \cdot \Delta U$$

If not, the system to be solved is:

$$f = 0 \Rightarrow |F^- + \Delta F - X^- - \Delta X| = F_e$$

$$\Delta U^{an} = \Delta \alpha = \Delta \lambda \frac{F^- + \Delta F - X^- - \Delta X}{F_e} \quad [\text{éq 4.2-1}]$$

$$\Delta F = K_e (\Delta U - \Delta U^{an})$$

The 3 unknown factors are: ΔF ; $\Delta U^{an} = \Delta \alpha$; $\Delta \lambda$ because $\Delta X = \frac{k(\alpha^- + \Delta \alpha)}{\left(1 + (k(\alpha^- + \Delta \alpha))^n\right)^{1/n}} - X^-$ is

an analytical function of $\Delta \alpha$.

One can simplify this system in the following way:

$$|F^- + \Delta F - X^- - \Delta X| = F_e$$

$$\Delta U^{an} = \Delta \lambda \frac{F^- + \Delta F - X^- - \Delta X}{F_e}$$

$$\Delta F + F^- - X^- - \Delta X = K_e (\Delta U - \Delta U^{an}) + F^- - X^- - \Delta X$$

$$|F^- + \Delta F - X^- - \Delta X| = F_e$$

thus:
$$\Delta U^{an} = \Delta \lambda \frac{F^- + \Delta F - X^- - \Delta X}{F_e}$$

[éq 4.2-2]

$$\Delta F + F^- - X^- - \Delta X = K_e \Delta U + F^- - X^- - \Delta X - K_e \Delta \lambda \frac{F^- + \Delta F - X^- - \Delta X}{F_e}$$

The last equation provides:

$(\Delta F + F^- - X^- - \Delta X)(1 + K_e \Delta \frac{\lambda}{F_e}) = K_e \Delta U + F^- - X^- - \Delta X$ where ΔX function of $\Delta \alpha$ thus of $\Delta \lambda$ (and of the sign of $F - X$). By taking the standard on the right and on the left one obtains:

$$F_e + K_e \Delta \lambda = |K_e \Delta U + F^- - X^- - \Delta X|$$

This single scalar equation can be solved by a classical method of search for zero of function (Newton, secant, etc to see for example [R5.03.04]). If kinematic work hardening is linear, (only thermodynamically justified case [feeding-bottle 8]) one obtains the solution analytically $\Delta \lambda$:

$$F_e + (K_e + k) \Delta \lambda = |K_e \Delta U + F^- - X^-|$$

One calculates then the other unknown factors by:

$$\Delta F = \frac{K_e \Delta U + F^- - X^- - \Delta X}{(1 + K_e \frac{\Delta \lambda}{F_e})} - F^- + X^- + \Delta X \quad \text{and} \quad \Delta U^{an} = \Delta \lambda \frac{F^- + \Delta F - X^- - \Delta X}{F_e}$$

The current programming solves the system in a simplified way:

$$f = |F - X| - F_e \text{ is discretized explicitly: } f = |F - X^-| - F_e$$

then: $F_e + K_e \Delta \lambda = |K_e \Delta U + F^- - X^-|$.

One calculates then $\alpha = \alpha^- + \Delta U^{an}$, which makes it possible to bring up to date:

$$X = \frac{k_r \alpha}{\left(1 + \left(\frac{k_r \alpha}{F_u}\right)^n\right)^{\frac{1}{n}}}$$

The tangent stiffness in this direction is approached by:

$$K_{tgt} = \frac{\Delta F}{\Delta U}$$

[éq 4.2-3]

4.3 Internal variables

There are 3 internal variables per degree of freedom:

- $V1$ contains U^{an} at every moment
- $V2$ contains α at every moment
- $V3$ contains at every moment reactualized total energy.

5 Nonlinear viscoelastic behavior DIS_VISC

5.1 Definition

The behavior `DIS_VISC` is a nonlinear viscoelastic rheological behavior, of type *Zener* extended, allowing to schematize the behavior of a uniaxial shock absorber, only according to the degree of freedom `DX` room of the discrete elements with two nodes (mesh `SEG2`) or and of the discrete elements to a node (mesh `POI1`), in the case of a connection with a frame fixes nonwith a grid (see static and dynamic examples in the case test `SSND101`). The fitting of the linear elastic components allows the pre onendre counts of it a broad range of situations of environment of the damping part of the device and of its fixings.

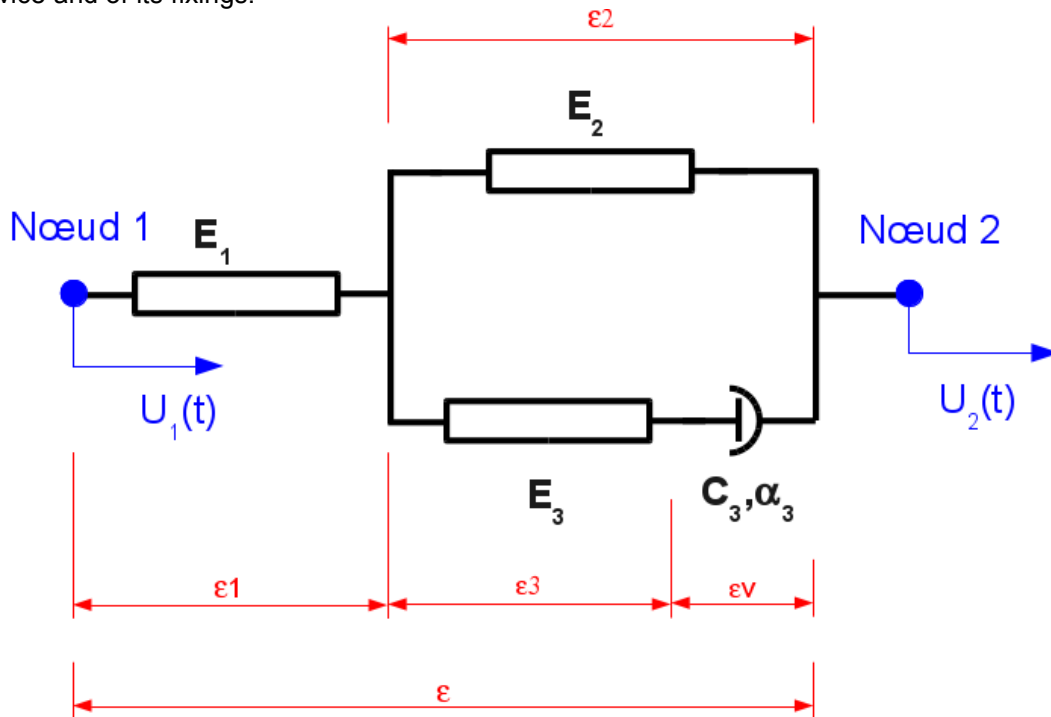

Figure 5.1-a : Discrete nonlinear viscoelastic model rheological.

The nonlinear viscous law is written, for $\alpha \in]0, 1]$:

$$\sigma_3 = E_3 \varepsilon_3 = C \cdot \text{sgn}(\dot{\varepsilon}_v) \cdot |\dot{\varepsilon}_v|^\alpha \quad [\text{éq 5.1-1}]$$

the damping ratio C being positive. For $\alpha = 1$, the model is viscous linear. One notes that dimension "time" of this problem is, by the rules of similarity, directly associated with the coefficient C : indeed,

by noting the time reduced by $\tau = \lambda t$, the nonlinear law is written: $\sigma_3 = C \cdot \lambda^\alpha \text{sgn}(\dot{\varepsilon}_v) \cdot \left| \frac{d\varepsilon_v}{d\tau} \right|^\alpha$.

Thus to consider a dynamic loading with a different pulsation (in report λ) is identical to change into proportion of λ^α the coefficient C law. It is noted that the case $E_2 \rightarrow \infty$ is not-acceptable, but one can choose $E_2 = 0$ (system in pure, standard series `MAXWELL`); in the same way one will not take $E_1 \rightarrow \infty$ and $E_3 \rightarrow \infty$ at the same time (model of `KELVIN-VOIGT`), or else the initial stiffness of the system would be infinite.

5.2 Formulation of the behavior

One notes hereafter by ε “deformation” of the discrete element, namely the difference of axial displacements (direction x in the local reference mark) of the nodes at the ends of the definite element:

$$\varepsilon = U_x^{N2} - U_x^{N1} \text{ on the mesh SEG2 or } \varepsilon = U_x^{N1} \text{ on the mesh POI1} \quad [\text{éq 5.2-1}]$$

In the same way, one notes hereafter by σ the “constraint” of the discrete element, namely the axial load forwarding in the element defined on the mesh SEG2 or POI1 :

$$\sigma = F_x^{N2} = F_x^{N1} \quad [\text{éq 5.2-2}]$$

The compatibility of the deformations gives, cf. Figure 5.1-a :

$$\begin{cases} \varepsilon &= \varepsilon_1 + \varepsilon_2 \\ \varepsilon_2 &= \varepsilon_3 + \varepsilon_v \end{cases} \quad [\text{éq 5.2-3}]$$

The balance and the relations of behavior give respectively (while being placed hereafter in the case $\text{sgn}(\dot{\varepsilon}_v) = +1$, for ε and σ positive):

$$\begin{cases} \sigma &= E_1 \varepsilon_1 \\ \sigma &= \sigma_2 + \sigma_3 = E_2 \varepsilon_2 + E_3 \varepsilon_3 \\ \sigma_3 &= E_3 \varepsilon_3 = C (\dot{\varepsilon}_v)^\alpha \end{cases} \quad [\text{éq 5.2-4}]$$

It is deduced respectively that:

$$\dot{\varepsilon}_2 = \left(\frac{\sigma_3}{C} \right)^{1/\alpha} + \frac{\dot{\sigma}_3}{E_3} \quad [\text{éq 5.2-5}]$$

$$\dot{\sigma} = E_2 \cdot \left(\frac{\sigma_3}{C} \right)^{1/\alpha} + \frac{\dot{\sigma}_3 (E_2 + E_3)}{E_3} \quad [\text{éq 5.2-6}]$$

And the evolution of the deformation is:

$$\dot{\varepsilon} = \frac{E_1 + E_2}{E_1} \left(\frac{\sigma_3}{C} \right)^{1/\alpha} + \frac{\dot{\sigma}_3 (E_1 + E_2 + E_3)}{E_1 E_3} \quad [\text{éq 5.2-7}]$$

Thus the total law of behavior of the rheological system is written of speed:

$$\dot{\sigma} = \frac{E_1 (E_2 + E_3) \dot{\varepsilon} - E_1 E_3 \cdot \dot{\varepsilon}_v}{E_1 + E_2 + E_3} \quad [\text{éq 5.2-8}]$$

Speed $\dot{\varepsilon}$ is calculated on the basis of displacement and the increment of selected time:

$$\dot{\varepsilon} = \left(U_x^{N2} - U_x^{N1} \right) / \Delta t .$$

It remains to express $\dot{\varepsilon}_v$, starting from the variables of state:

$$\dot{\varepsilon}_v = \left(\frac{1}{C} \left(\frac{\sigma (E_1 + E_2)}{E_1} - E_2 \varepsilon \right) \right)^{1/\alpha} \quad [\text{éq 5.2-9}]$$

The elastic tangent stiffness speed of the model, which is used with the phase as prediction, is:

$$K_t = \frac{E_1(E_2 + E_3)}{E_1 + E_2 + E_3} = \frac{1 + E_2/E_3}{1/E_1 + E_2/(E_1 \times E_3) + 1/E_3} \quad [\text{éq 5.2-10}]$$

The dissipated power is expressed by:

$$P_{diss} = C |\dot{\epsilon}_v|^{1+\alpha} \quad [\text{éq 5.2-11}]$$

In the speed plan of deformation-constraint in the rheological model, for various values of α , the following cycles are observed:

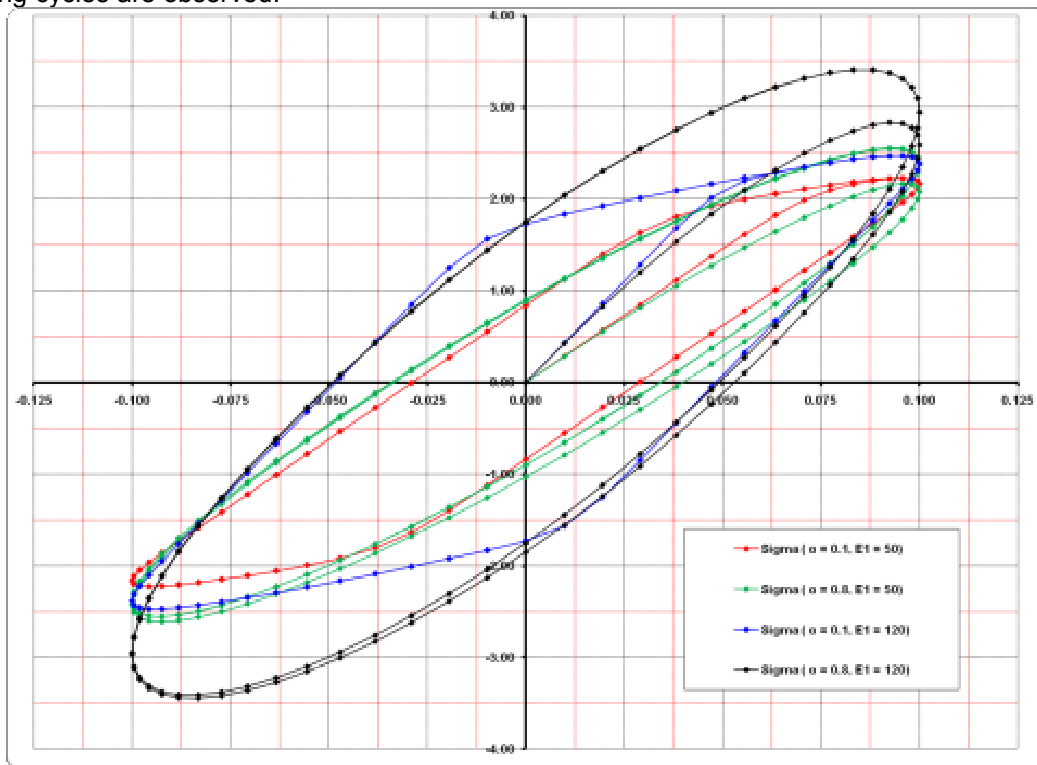

Figure 5.2-a : Cycles of answer of the viscoelastic rheological model nonlinear discrete (model generalized Zener).
Force in Newton function of displacement in meters.

Note:

The slope of the cycles comes from the effect of the stiffnesses in parallel in rheological behavior (Kelvin-Voigt or Zener) or in series (model Maxwell). Indeed, in the case of a shock absorber alone without stiffness, the cycles are necessarily symmetrical compared to the axis of worthless displacements. If one has experimental curves of behavior of such a damper, one will be able by retiming to thus determine the various coefficients of this law DIS_VISC .

5.3 Setting in data

The coefficients material are provided by the keyword `DIS_VISC` order `DEFI_MATERIAU`.

For the local direction x (and only that one) of the discrete element, one provides 5 coefficients, either the stiffnesses, or the flexibilities, then the damping characteristics:

- $K1$: elastic stiffness E_1 element 1 of the rheological model,
- $K2$: elastic stiffness E_2 element 2 of the rheological model,
- $K3$: elastic stiffness E_3 element 3 of the rheological model,

- UNSUR_K1 : elastic flexibility $1/E_1$ element 1 of the rheological model,
- UNSUR_K2 : elastic flexibility $1/E_2$ element 2 of the rheological model,
- UNSUR_K3 : elastic flexibility $1/E_3$ element 3 of the rheological model,
- PUIS_ALPHA : power α nonlinear law of the viscous behavior of the element,
- C : coefficient of the viscous behavior of the element.

The conditions to respect for these coefficients are (in particular to ensure the positivity and the finitude of the tangent matrix):

$$E_1 \geq 10^{-8} ; 1/E_1 \geq 0 ; E_3 \geq 10^{-8} ; 1/E_3 \geq 0$$

$$1/E_2 \geq 10^{-8} ; E_2 \geq 0 ; C \geq 10^{-8} ; 10^{-8} \leq \alpha \leq 1$$

Moreover, one cannot have at the same time: $1/E_1=0$, $1/E_3=0$ and $E_2=0$, i.e. the case of the shock absorber alone.

5.4 Integration of the behavior

5.4.1 Local integration

A diagram of EULER implicit is much less precise (it would be necessary to calculate the error with order 2) than a diagram of RUNGE-KUTTA of order 5 with a control of the error. The diagram RK5 is a combination of the diagram of order 4 and diagram of order 6 (feeding-bottle [9]), for which the coefficients are given in order to minimize the error between order 4 and order 6.

This is why in Code_Aster, the local integration of this model uses the diagram of RUNGE-KUTTA of order 5. Moreover, tangent stiffness after discrete discretization in time of the behavior dF/dU is obtained directly via the expression of the diagram RUNGE-KUTTA, at the end of the step of time.

The error is known, it is thus possible to start local subdivisions of the step of time if the convergence criteria are not respected.

5.4.2 Integration temporal and balances total

In addition, if one considers the dynamic balance of a system to a degree of freedom, of mass M , comprising a shock absorber alone (without stiffnesses) obeying the law [éq 5.1-1], the equation of the movement is written, having adopted it " reduced time " $\tau = \lambda t$:

$$M \frac{\partial^2 u}{\partial \tau^2} + C \cdot \lambda^{2-\alpha} \cdot \text{sgn} \left(\frac{\partial u}{\partial \tau} \right) \cdot \left| \frac{\partial u}{\partial \tau} \right|^\alpha = 0 \quad [\text{éq 5.4.2-1}]$$

Let us adopt for example the diagram of temporal integration of Newmark, cf [R5.05.05], section § 3.1; one notes at the moment τ_i the sizes displacement, speed and acceleration: u_i , v_i , a_i and $\Delta \tau$ the step of "reduced time". One thus has at the moment τ_{i+1} :

$$\begin{cases} v_{i+1} = \frac{\gamma}{\beta \Delta \tau} (u_{i+1} - u_i) + \frac{\beta - \gamma}{\beta} v_i + \frac{2\beta - \gamma}{2\beta} \Delta \tau \cdot a_i \\ a_{i+1} = \frac{1}{\beta \Delta \tau^2} (u_{i+1} - u_i) - \frac{1}{\beta \Delta \tau} v_i + \frac{2\beta - 1}{2\beta} \cdot a_i \end{cases} \quad [\text{éq 5.4.2-2}]$$

Let us inject these expressions [éq 5.2-4] to write balance [éq 5.4.2-1] at the moment τ_{i+1} , in the case $v_i \geq 0$, developed with the first order in Δv :

$$\hat{K} u_{i+1} = \frac{M u_i}{\beta \Delta \tau^2} + \frac{M v_i}{\beta \Delta \tau} - \frac{2\beta - 1}{2\beta} \cdot M a_i + C \cdot \lambda^{2-\alpha} \cdot \left(\frac{\beta - \gamma}{\beta} v_i + \frac{2\beta - \gamma}{2\beta} \Delta \tau \cdot a_i \right)^{1-\alpha} \quad [\text{éq 5.4.2-3}]$$

the tangent matrix being:

$$\hat{K} = \frac{M}{\beta \Delta \tau^2} + \frac{\alpha \gamma C \lambda^{2-\alpha}}{\beta \Delta \tau} \cdot \left(\frac{\beta - \gamma}{\beta} v_i + \frac{2\beta - \gamma}{2\beta} \Delta \tau \cdot a_i \right)^{\alpha-1} \quad [\text{éq 5.4.2-4}]$$

In the case $\alpha=1$ (linear shock absorber), one finds the tangent matrix \hat{K} and dependence with the step of time Δt usual of the diagram of Newmark for the linear case, cf [R5.05.05].

In the case $\alpha \neq 1$ (nonlinear shock absorber), it is observed that v_i and a_i not being able to be worthless unit (except in statics), tangent matrix \hat{K} diagram of Newmark sees its dependence with the step of time affected by the factor $C \cdot \lambda^{2-\alpha}$. Thus if one varies the coefficient C law, one will have to vary the step of time of temporal integration. One will be able to also adopt a technique of subdivision of the step of time, cf operator `STAT_NON_LINE` [U4.51.03] and operator `DYNA_NON_LINE` [U4.53.01].

This model of behavior on discrete element is also available to identical within the operators `DYNA_VIBRA` [U4.53.03] and `DYNA_TRAN_MODAL` [U4.53.21], for a dynamic analysis on modal basis with non-linearities located on nodes, and diagrams of integration in time of the dynamics of the type Euler or Runge-Kutta type of order 5 and order 3, to adaptive step. It is integrated there locally in time in the same way: to see § 5.4.1. One will have, as in dynamics on physical basis, to define the step of time of the diagram according to the parameters of the law `DIS_VISC`, of which the values are directly defined in the operators `DYNA_VIBRA` and `DYNA_TRAN_MODAL`.

5.5 Internal variables

The behavior `DIS_VISC` have 4 internal variables:

- $V1$: `FORCE` : the effort contains σ at every moment in rheological model.
- $V2$: `UVISQ` : viscous displacement of the shock absorber ε_v .
- $V3$: `DISSTHER` : contains at every moment reactualized dissipated energy:

$$V3 = \sum \left| \frac{\sigma^+(E_1 + E_2)}{E_1} - E_2 \varepsilon^+ \right| \cdot |\varepsilon_v^+ - \varepsilon_v^-|$$

- $V4$: `STIFFNESS` : tangent stiffness with the behavior dF/dU .

6 Non-linear behavior DIS_ECRO_TRAC

6.1 Definition

The behavior DIS_ECRO_TRAC is a nonlinear behavior who bracket is:

- with degree of freedom DX room of the discrete elements with two nodes (mesh SEG2) or and of the discrete elements to a node (mesh POI1). The behavior is of standard “isotropic work hardening”.
- in tangent plan YZ room of the discrete elements with two nodes (mesh SEG2) or and of the discrete elements to a node (mesh POI1). The behavior is of standard “isotropic work hardening” or “kinematic work hardening”.

The non-linear behavior is given by a curve $F = fonction(\Delta U)$:

- for one SEG2, ΔU represent the relative displacement of the 2 nodes in the local reference mark of the element.
- for one POI1, ΔU represent the absolute displacement of the node in the local reference mark of the element.
- for one SEG2 or one POI1, F represent the effort expressed in the local reference mark of the element.

6.2 Setting in data

The only data necessary is the function describing the non-linear behavior. This function must respect the criteria according to:

- It is a function within the meaning of code_aster : defined with the operator DEFI_FONCTION,
- The interpolations on the ordinate and x-axes are linear,
- The name of the X-coordinate at the time of the definition of the function is DX, or DTAN,
- The prolongations on the left and on the right of the function are excluded,
- The function must be defined by at least 3 points, for an isotropic function of work hardening,
- The function must be defined by exactly 3 points, for a kinematic function of work hardening,
- The first point is (0.0,0.0) and must be given,
- The function must be strictly increasing,
- The derivative of the function must be lower or equal to its derivative to the point (0.0,0.0) .

The first two points of the function make it possible to define the elastic slope in the behavior. The units of the X-coordinates and the ordinates must be coherent with those of the problem:

- X-coordinate must be homogeneous with one Déplacement,
- the ordinate (value of function) must be homogeneous with one effort.

6.3 Formulation of the behavior

The formulation is identical to that which one uses in plasticity isotropic or kinematic:

- The threshold is represented by the function describing the non-linear behavior
- Elastic stiffness k_{elas} is defined by the initial slope of the curve.

Under these conditions: $f = ||F - X|| - R(p)$

Where:

- F : is the vector effort (F_x, F_y, F_z) .
- X : is the vector D' kinematic work hardening (X_x, X_y, X_z) .
- p : the plastic flow.
- R : function of the isotropic or kinematic work hardening.

The behavior is described by the following equations, with i the local axis (x, y, z) :

$$\dot{F}_i = K_{elas} \cdot (\dot{U}_i - \dot{U}_i^p)$$

if $f \leq 0$:

$$\dot{\lambda} = 0$$

if $f=0$ and $\dot{f}=0$:

$$\dot{U}_i^p = \dot{\lambda} \cdot \frac{\partial f}{\partial F_i}$$

- case of kinematic work hardening:

$$\dot{\alpha}_i = -\dot{\lambda} \frac{\partial f}{\partial X_i} \text{ with } \dot{X}_i = -C \cdot \dot{\alpha}_i \text{ and } C \text{ slope of kinematic work hardening.}$$

- case of isotropic work hardening

$$\dot{p}_i = -\dot{\lambda} \frac{\partial f}{\partial R}$$

The increment of dissipation is given by: $\dot{W} = F \cdot \dot{U}^p$

6.4 Local integration of the behavior

The diagram used is that of RUNGE-KUTTA of order 5 with a control of the error. The diagram RK5 is a combination of the diagram of order 4 and diagram of order 6 (feeding-bottle [9]), for which the coefficients are given in order to minimize the error between order 4 and order 6.

In *Code_hasster*, the local integration of this model uses the diagram of RUNGE-KUTTA of order 5.

The error is known, it is thus possible to start local subdivisions of the step of time if the convergence criteria are not respected.

6.5 Internal variables

The behavior DIS_ECRO_TRAC have 14 internal variables:

	Name of the variable	
V1	FORCEX	Force along the local axis X of the element.
V2	FORCEY	Force along the local axis there of the element.
V3	FORCEZ	Force along local axis Z of the element.
V4	DEPLX	Displacement along the local axis X of the element.
V5	DEPLY	Displacement along the local axis there of the element.
V6	DEPLZ	Displacement along local axis Z of the element.
V7	DISSTHER	Dissipation.
V8	PCUM	Plastic indicator.
V9	DEPLPX	Unelastic displacement along the local axis X of the element.
V10	DEPLPY	Unelastic displacement along the local axis there of the element.
V11	DEPLPZ	Unelastic displacement along local axis Z of the element.
V12	FORCXX	Kinematic work hardening following the local axis X of the element.
V13	FORCXY	Kinematic work hardening following the local axis there of the element.
V14	FORCXZ	Kinematic work hardening following local axis Z of the element.

7 Modeling of the shocks and friction: DIS_CHOC

The behavior DIS_CHOC translated the contact with shock and friction between two structures, via two types of relations:

- the relation of unilateral contact which expresses to it not inter-penetrability between the solid bodies,
- the relation of friction which governs the variation of the tangential stresses in the contact. One will retain for these developments a simple relation: the law of friction of Coulomb.

7.1 Relation of unilateral contact

Are two structures Ω_1 and Ω_2 . One notes $d_N^{1/2}$ the normal distance enters the structures, $F_N^{1/2}$ the force of normal reaction of Ω_1 on Ω_2 .

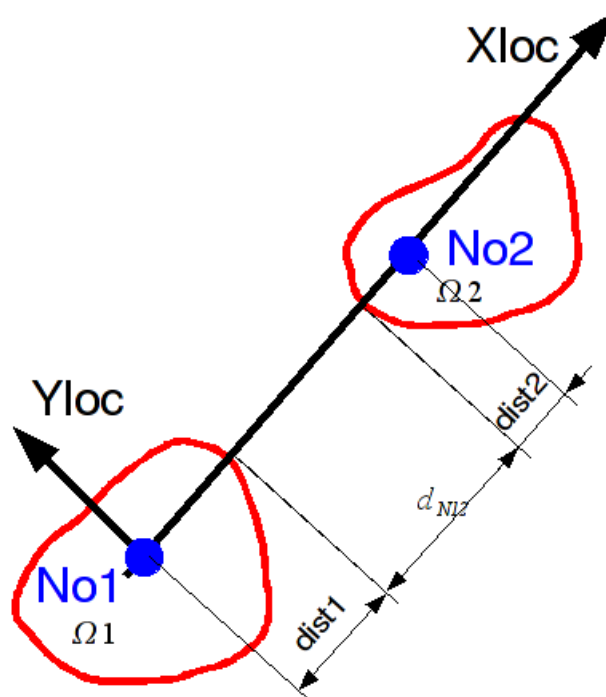

Figure 7.1-a : Definition of the distances for the relation DIS_CHOC.

In the local reference mark with the element, the normal distance d_N has as an expression:

$$d_N = ((X_{loc2}^0 + u_2) - (X_{loc1}^0 + u_1)) - dist1 - dist2$$

The law of the action and the reaction imposes:

$$F_N^{2/1} = -F_N^{1/2} \quad [\text{éq 7.1-1}]$$

The conditions of unilateral contact, still called conditions of Signorini [bib5], are expressed in the following way:

$$d_N^{1/2} \geq 0, F_N^{1/2} \geq 0, d_N^{1/2} \cdot F_N^{1/2} = 0 \text{ and } F_N^{2/1} = -F_N^{1/2} \quad [\text{éq 7.1-2}]$$

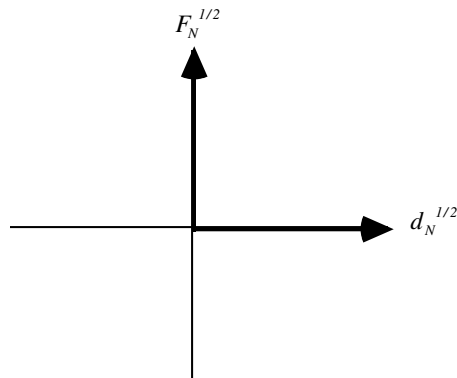

Figur Re 7.1-b : Gra phe of the relation of unilateral contact.

This graph translates a relation force-displacement which is not differentiable. It is thus not usable in a simple way in a dynamic calculation algorithm.

7.2 Law of friction of Coulomb

The law of Coulomb expresses a tangential limitation of effort $\mathbf{F}_T^{1/2}$ of tangential reaction of Ω_1 on Ω_2 . That is to say $\dot{\mathbf{u}}_T^{1/2}$ the relative speed of Ω_1 compared to Ω_2 in a point of contact and is μ the coefficient of friction of Coulomb, one has [bib5]:

$$s = \|\mathbf{F}_T^{1/2}\| - \mu \cdot F_{N^{1/2}} \leq 0, \quad \exists \lambda \quad \dot{\mathbf{u}}_T^{1/2} = \lambda \mathbf{F}_T^{1/2}, \quad \lambda \leq 0, \quad \lambda \cdot s = 0 \quad [\text{éq 7.2-1}]$$

and the law of the action and the reaction:

$$\mathbf{F}_T^{2/1} = -\mathbf{F}_T^{1/2} \quad [\text{éq 7.2-2}]$$

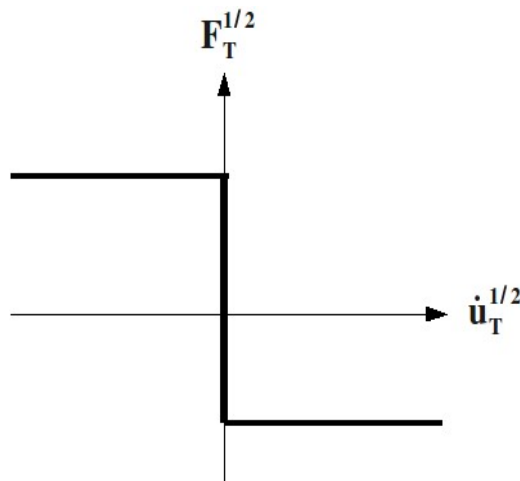

Figure 7.2-a : Graph of the law of friction of Coulomb.

The graph of the law of Coulomb is also nondifferentiable and is thus not simple to use in a dynamic algorithm.

Note:

The law of friction of Coulomb is written of speed. During a static calculation (cf §7.3.3), the writing will be made in increment of displacement.

7.3 Approximate modeling of the relations of contact by penalization

7.3.1 Model of normal force of contact

The principle of the penalization applied to the graph of [Figure 5.3.1-a] consists in introducing a univocal relation $F_N^{1/2} = f_\varepsilon(d_N^{1/2})$ by means of a parameter ε . The graph of f_ε must tend towards the graph of Signorini when ε tends towards zero [bib6].

One of the possibilities consists in proposing a linear relation enters $d_N^{1/2}$ and $F_N^{1/2}$:

$$F_N^{1/2} = -\frac{1}{\varepsilon} d_N^{1/2} \text{ if } d_N^{1/2} \leq 0 ; F_N^{1/2} = 0 \text{ if not} \quad [\text{éq 7.3.1-1}]$$

If one notes $K_N = \frac{1}{\varepsilon}$ called commonly “**stiffness of shock**“, one finds the classical relation, modelling an elastic shock:

$$F_N^{1/2} = -K_N \cdot d_N^{1/2} \quad [\text{éq 7.3.1-2}]$$

The approximate graph of the law of contact with penalization is the following:

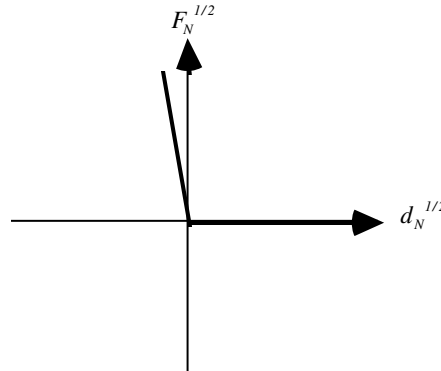

Figure 7.3.1-a : Graph of the relation of unilateral contact approached by penalization.

In dynamics, to take account of a possible loss of energy in the shock, one introduces a “damping of shock” C_N . The expression of the normal force of contact is expressed then by:

$$F_{N1/2} = -K_N \cdot d_{N1/2} - C_N \cdot \dot{u}_{N1/2} \quad [\text{éq 7.3.1-3}]$$

where $\dot{u}_{N1/2}$ is the relative normal speed of Ω_1 compared to Ω_2 . To respect the relation of Signorini (not blocking), one must on the other hand check a posteriori that $F_N^{1/2}$ is positive or worthless. Only the positive part will thus be taken $\langle \rangle^+$ expression [éq 7.3.1-3]:

$$\begin{aligned} \langle x \rangle^+ &= x & \text{if } x \geq 0 \\ \langle x \rangle^+ &= 0 & \text{if } x < 0 \end{aligned}$$

The complete relation giving the normal force of contact which is retained for the algorithm is the following one:

$$\left. \begin{aligned} \text{si } d_N^{1/2} \leq 0 \quad F_N^{1/2} &= \langle -K_N \cdot d_N^{1/2} - C_N \cdot \dot{u}_{N1/2} \rangle^+ ; \quad F_N^{2/1} = -F_N^{1/2} \\ \text{sinon } F_N^{2/1} &= F_N^{1/2} = 0 \end{aligned} \right\} \quad [\text{éq 7.3.1-4}]$$

7.3.2 Model of tangential force of contact in dynamics

The graph describing the tangential force with law of Coulomb is not-differentiable for the phase of adherence $\dot{u}_T^{1/2} = 0$. One thus introduces a univocal relation binding relative tangential displacement

$\mathbf{d}_T^{1/2}$ and the tangential force $\mathbf{F}_T^{1/2} = f_\xi(\mathbf{d}_T^{1/2})$ by means of a parameter ξ . The graph of F_ξ must tend towards the graph of Coulomb when ξ tends towards zero [bib6].

One of the possibilities consists in writing a linear relation enters $\mathbf{d}_T^{1/2}$ and $\mathbf{F}_T^{1/2}$:

while noting a^0 the value of a quantity has at the beginning of the step of time:

$$\mathbf{F}_T^{1/2} - \mathbf{F}_T^{1/2\ 0} = -\frac{1}{\xi} \cdot (\mathbf{d}_T^{1/2} - \mathbf{d}_T^{1/2\ 0}) \quad [\text{éq 7.3.2-1}]$$

If one introduces a "tangential stiffness" $K_T = \frac{1}{\xi}$, the relation is obtained:

$$\mathbf{F}_T^{1/2} = \mathbf{F}_T^{1/2\ 0} - K_T \cdot (\mathbf{d}_T^{1/2} - \mathbf{d}_T^{1/2\ 0}) \quad [\text{éq 7.3.2-2}]$$

For digital reasons, related to the dissipation of parasitic vibrations [bib7] in phase of adherence, one is brought to add a "tangential damping" C_T in the expression of the tangential force. Its final expression is:

$$\mathbf{F}_T^{1/2} = \mathbf{F}_T^{1/2\ 0} - K_T \cdot (\mathbf{d}_T^{1/2} - \mathbf{d}_T^{1/2\ 0}) - C_T \cdot \dot{\mathbf{u}}_T^{1/2}, \quad \mathbf{F}_T^{2/1} = -\mathbf{F}_T^{1/2} \quad [\text{éq 7.3.2-3}]$$

It is necessary moreover than this force checks the criterion of Coulomb, that is to say:

$$\|\mathbf{F}_T^{1/2}\| \leq \mu \cdot F_N^{1/2} \quad \text{if not one applies } F_T^{1/2} = -\mu \cdot F_N^{1/2} \cdot \frac{\dot{\mathbf{u}}_T^{1/2}}{\|\dot{\mathbf{u}}_T^{1/2}\|}, \quad \mathbf{F}_T^{2/1} = -\mathbf{F}_T^{1/2} \quad [\text{éq 7.3.2-4}]$$

The approximate graph of the law of friction of Coulomb modelled by penalization is the following:

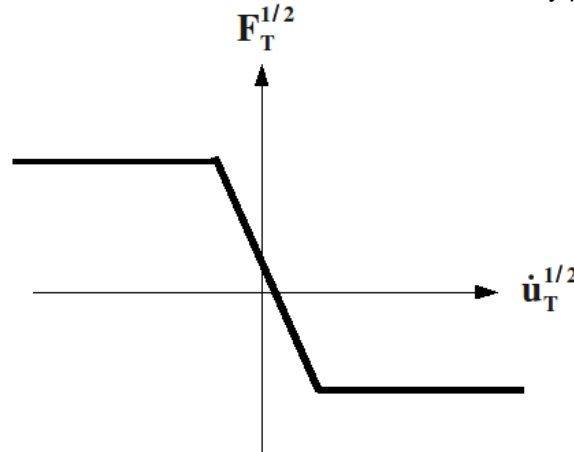

Figure 7.3.2-a : Graph of the law of friction approached by penalization.

7.3.3 Model of tangential force of contact in statics

By introducing as in dynamics a tangential stiffness:

$$\mathbf{F}_T^{1/2} = K_T \cdot (\mathbf{d}_T^{1/2} - \delta),$$

where δ is the tangential slip.

While noting δ^0 the tangential slip at the beginning of the step, one starts by evaluating:

$$\mathbf{F}_T^0 = K_T \cdot (\mathbf{d}_T^{1/2} - \delta^0)$$

If $\|\mathbf{F}_T^{1/2}\| \leq \mu \cdot F_N^{1/2}$ then $\delta = \delta^0$.

If not, as in plasticity, one introduces a multiplier λ :

$$\Delta \delta = \lambda \mathbf{F}_T^0 / K_T$$

and one obtains $\lambda = 1 - \frac{\mu F_N^{1/2}}{\|\mathbf{F}_T^0\|}$.

7.4 Definition of the parameters of contact

One specifies the keywords here allowing to define the parameters of contact, damping and friction [U4.43.01]:

The operand `RIGI_NOR` is obligatory, it allows to give the value of normal stiffness of shock K_N .

The other operands are optional:

- The operand `AMOR_NOR` allows to give the value of normal damping of shock C_N .
- The operand `RIGI_TAN` allows to give the value of tangential stiffness K_T .
- The operand `AMOR_TAN` allows to give the tangential value of damping of shock C_T .
- The operand `COULOMB` allows to give the value of the coefficient of Coulomb.
- The operand `DIST_1` allows to define the distance characteristic of matter surrounding the first node of shock
- The operand `DIST_2` allows to define the distance characteristic of matter surrounding the second node of shock (shock between two mobile structures)
- The operand `GAME` defines the distance between the node of shock and an obstacle not modelled (case of a shock between a mobile structure and an indeformable and motionless obstacle).

8 Modeling of the connection grid-pencil: DIS_GRICRA

The behavior `DIS_GRICRA` is used to model the behavior in translation and in rotation within the competences of connection – pencil of the fuel assemblies roasts. The law of behavior was conceived to be used with the discrete ones with two nodes `MECA_DIS_TR_L`.

8.1 General presentation

The maintenance of the pencils in the cells of grid is ensured by the system of bosses and springs represented on the following figure:

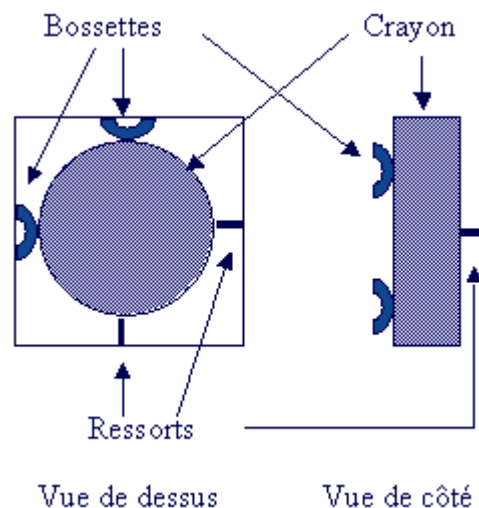

Figure 8.1-a : Diagram of Ucell of grid.

The pencil is thus maintained in the cell of grid by 6 points of contact (cf appears 8.1-a): 4 bosses and 2 springs. It is possible to model each element of contact (bosses and springs) thanks to discrete elements, to which one affects a law of friction of the type `DIS_CHOC`. Such a modeling makes it possible satisfactorily to represent the behavior of a cell of grid in translation (extraction of the pencil) and in rotation. Such a method has the following disadvantages however:

- Complexity of the grid to be produced, because one needs 6 discrete per cell of grid (or grid in a homogenized model), with different heights for the bosses and the springs.
- Complexity in the definition of the characteristics of the discrete ones, because it is necessary to differentiate the bosses and the springs
- Dissymmetry of modeling (boss on a side and arises in opposition), whereas the behavior homogenized on a grid can be regarded as symmetrical, taking into account the alternation of the orientation of the cells of grid in the grids.
- Difficulties to identify the parameters of the behavior of discrete at the level of a fuel assembly.

A called equivalent modeling `DIS_GRICRA` was proposed, which makes it possible to find the same behavior as the system of 6 discrete in translation and rotation, while avoiding the disadvantages quoted above:

- The connection grid-pencil is modelled by 4 discrete elements in cross in the same plan, which simplifies the grid and makes it possible to symmetrize the problem.
- The 4 elements are affected same parameters for the law of behavior `DIS_GRICRA`.
- Behaviours in translation and rotation are treated separately, which facilitates an identification of the parameters.

Note:

In order to correctly represent the behavior of the connection in all the directions, especially in rotation, it is necessary to use 4 discrete laid out in cross, the pencil being related to discrete in the middle of the device in cross.

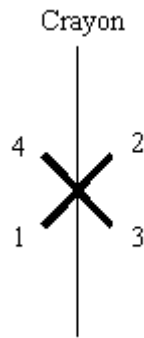

Figure 8.1-b : Device of 4 discrete in cross necessary to modeling of Comportement of a cell of grid.

8.2 Definition of the local reference mark

The equations of the law of behavior are written in the local reference mark of the discrete one. Taking into account the orthotropic character of the behavior in the tangential directions with discrete, one adopts following convention for the local definition of the reference mark of the discrete one: the axis x represent the axis of discrete, the axis y corresponds to the direction of the pencil, and centers it z is the orthogonal axis with x and y . For the swing angles, one will note Φ the swing angle around the axis x (DRX) and θ the swing angle around the axis z (DRZ). One is not interested in the swing angle around there (DRY MARTINI), because it is necessary to block this rotation (condition limits) in the command file.

With this definition of the local reference mark, direction y is common to all discrete system in cross represented on the figure 8.1-b. Direction x discrete 1 and 2 corresponds to the direction z discrete 3 and 4 (and vice versa). The angle Φ from 1 and 2 corresponds to the angle θ from 3 and 4 (and vice versa).

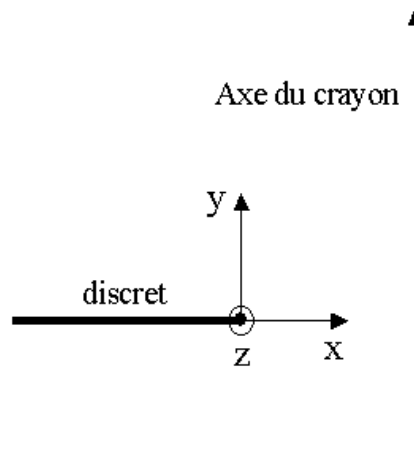

Figure 8.2-a : Définition of the local reference mark.

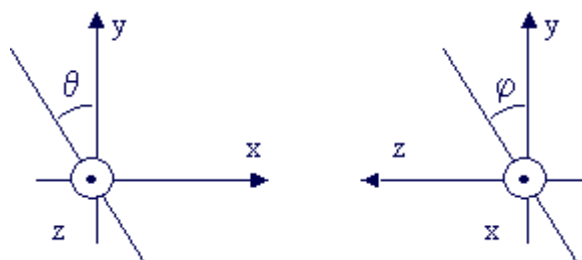

Figure 8.2-b : Definition of the yeargles.

8.3 Behavior in translation

8.3.1 Presentation of the behavior

The behavior in translation is modelled by a law of type friction of Coulomb [Figure 8.2-a].

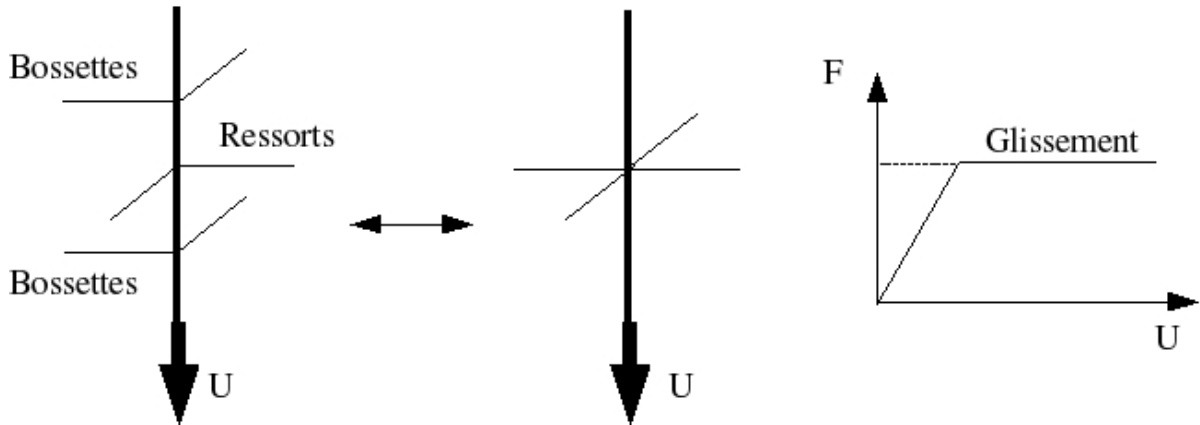

Figure 8.3.1-a : Lo I of behavior in translation.

Types of different behaviors are affected according to the directions:

Direction x

One considers an elastic behavior, with an initial force with null displacement equal contrary to the gripping force (the force exerted by the pencil on the discrete one compresses the discrete one):

$$F_x = K_N \Delta x - F_N^0$$

Direction y

One considers a quasi-perfect elastoplastic behavior to model the friction of Coulomb and the possibility of slip. The force is expressed in the following way:

$$F_y = K_T [\Delta y - U_y^p]$$

where Δy is the deformation of discrete according to y and U_y^p represent the slip

The criterion of slip is the following:

$$\|F_y\| \leq F^S + \kappa \lambda \text{ with } F^S = -\mu F_N^0$$

where κ is a parameter of the model, λ is the parameter of work hardening and μ is the coefficient

of Coulomb. The law of flow is the following one: $\dot{U}_y^p = \dot{\lambda} \frac{\mathbf{F}_y}{\|\mathbf{F}_y\|}$

See document [R5.03.09] on the integration of the nonlinear laws 1D for the digital integration of this elastoplastic law of type Von Mises with isotropic work hardening.

This force is identical for the 4 discrete system in cross, because they have the same direction y .

Direction z

It is pointed out that the law of behavior grid-pencil DIS_GRICRA must be used with a configuration of discrete in cross. It is consequently useless to define a force in the direction z the discrete one, because rigidity "is taken again" by the discrete orthogonal ones (cf preceding section).

8.3.2 Introduced parameters

The behavior in translation requires the introduction of 5 parameters:

- KN_AX : axial rigidity of the discrete one
- KT_AX : tangential rigidity (in the direction of slip) of the discrete one
- F_SER or F_SER_FO : gripping force of the pencil in the grid, the axial direction of the discrete one
- COUL_AX : coefficient of Coulomb for the law of friction
- ET_AX : parameters of work hardening allowing to make converge the law of friction. This parameter is optional, a value of 10^{-7} by default in Code_Aster is proposed.

The force necessary to extract a pencil from a grid is equal to $F_SER * COUL_AX$ (force of extraction).

8.4 Behaviour in rotation

8.4.1 Presentation of the behavior

The study of the connection grid-pencil in rotation with the system boss-springs showed that one could describe the behavior by superimposing two simple behaviors:

- a phenomenon of slip of the orthogonal elements to the plan of rotation, modelled by a law of Coulomb similar to that used in translation [Figure 8.3.1-a].
- a bilinear elastic behavior in the plan of rotation, induced by the possibility of separation of the pencil compared to a boss starting from a certain angle [Figure 8.3.1-a].

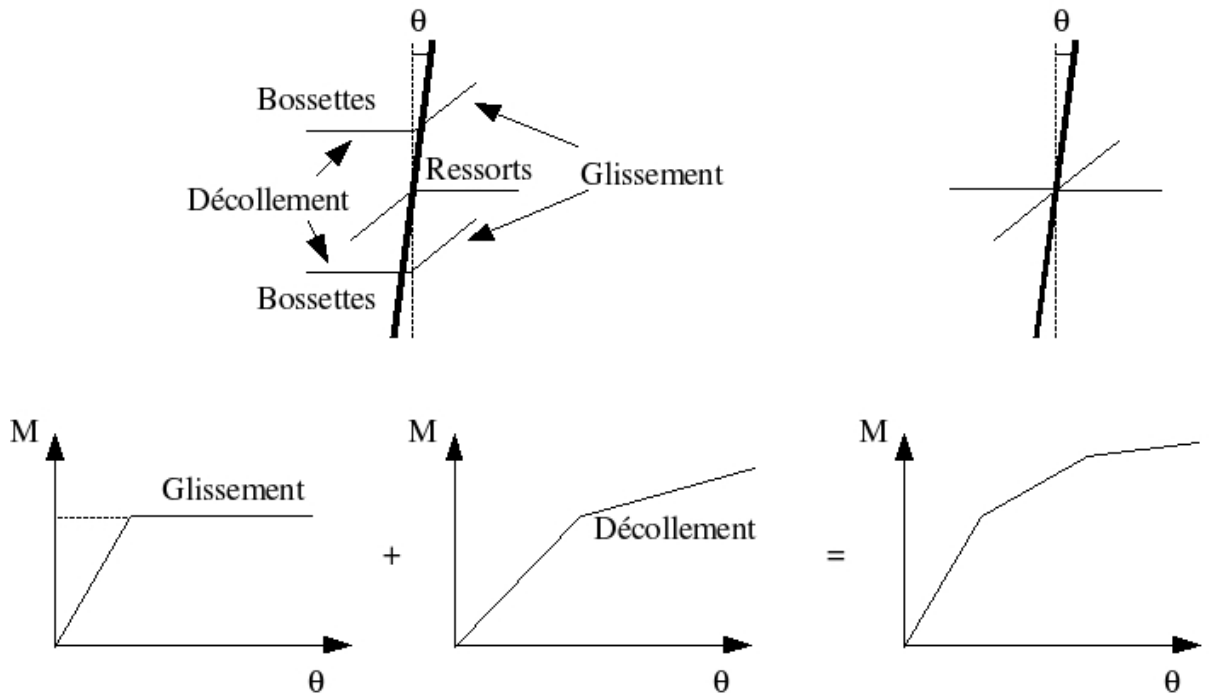

Figur Re 8.4.1-a : Sch Emma of the behavior of the connection grid-pencil in rotation.

It is to ensure this superposition of an elastoplastic behavior and with a bilinear elastic behavior that the configuration of 4 discrete in cross is necessary. If a rotation of an angle is considered θ in the total reference mark corresponding to the local reference mark from discrete the 1 and 2, this angle corresponds to the angle Φ discrete 3 and 4. It is then enough to impose on discrete the elastoplastic law on the angle θ (local reference mark) and the bilinear elastic law on the angle Φ (local reference mark) to have a superposition of the two behaviors thanks to the system the discrete ones in cross.

Types of different behaviors are affected according to the angles:

Rotation around the axis x

One considers an elastoplastic behavior of type Von Mises with isotropic work hardening to model friction in rotation. The moment is expressed according to the angle and of a "plastic" angle or angle of repose:

$$M_x = K_\phi [\phi - \phi^p]$$

where ϕ is the swing angle around x and ϕ^p represent the angle of repose

The criterion of slip is the following:

$\|M_\phi\| \leq M^S + \kappa \lambda$ where κ is a parameter of the model, λ is the parameter of work hardening and M^S is the moment-threshold defined by parameters of the model.

The law of flow is the following one:

$$\dot{M}_\phi^p = \lambda \frac{M_\phi}{\|M_\phi\|}$$

See document [R5.03.09] on the integration of the nonlinear laws 1D for the digital integration of this elastoplastic law of type Von Mises with isotropic work hardening, by replacing the force by the moment and the deformation by the difference in angle.

Rotation around the axis z

The behavior around the axis z is considered elastic bilinear. Moment around the axis z express yourself according to the swing angle around the axis z in the following way:

$$M_\theta = K^1 \theta \text{ if } \theta \in [-\theta^s, \theta^s]$$

$$M_\theta = K^2 \theta [\theta - \theta^s] + K^1 \theta^s$$

where θ^s is the angle of elastic break of slope.

Rotation around the axis y

With regard to rotation around the axis y , it is imperative to block this rotation because no law was identified for this degree of freedom, the not turning pencil. However, in order to limit the bad conditioning of the matrix of rigidity, a rigidity is introduced into the code, starting from other rigidities in rotation. This rigidity is invisible for the user and does not have an influence on calculations, the corresponding degree of freedom being blocked.

8.4.2 Introduced parameters

Behaviour in rotation requires the introduction of 5 parameters, that is to say in the form of constants (ANG1, ANG2, PEN1, PEN2, PEN3), that is to say in the form of functions of the temperature and the irradiation (ANG1_FO, ANG2_FO, PEN1_FO, PEN2_FO, PEN3_FO). An optional additional parameter ET_ROT (equal to 10E-7 by default) makes it possible to make converge the behavior of slip. The role of each parameter is explained easily over the curved angle-moment represented on the figure 8.4.1-a :

- At the beginning, there is no slip and not separation, rigidity in rotation is equal to PEN1 (or PEN1_FO).
- Starting from the angle ANG1 (or ANG1_FO), the phenomenon of slip on the discrete orthogonal ones with the plan of rotation is activated, these elements thus do not take part any more in rigidity in rotation and the slope decreases and becomes PEN2 (or PEN2_FO).
- Starting from the angle ANG2 (or ANG2_FO), there is always the slip, to which the separation of the pencil compared to certain bosses is added, from where a reduction in rigidity. This one becomes equal to PEN3 (or PEN3_FO).
- When then one discharges, there is always separation, but there is no more slip, the slope becomes PEN1-PEN2+PEN3 (or PEN1_FO-PEN2_FO+PEN3_FO).

- When one reaches twice $ANG1$ (or $ANG1_FO$) starting from the beginning of the discharge, the slip is reactivated, and there is always separation, from where a slope equalizes with $PEN3$ (or $PEN3_FO$).
- From $ANG2$ (or $ANG2_FO$), there is sticking together of the pencil on the bosses, from where a slope equalizes with $PEN2$ (or $PEN2_FO$).

Values of parameters used for the figure 8.4.1-a are the following: $ANG1=0.001\text{rad}$, $ANG2=0.004\text{rad}$, $PEN1=1000\text{ N.m.rad}^{-1}$, $PEN2=250\text{ N.m.rad}^{-1}$, $PEN3=90\text{ N.m.rad}^{-1}$.

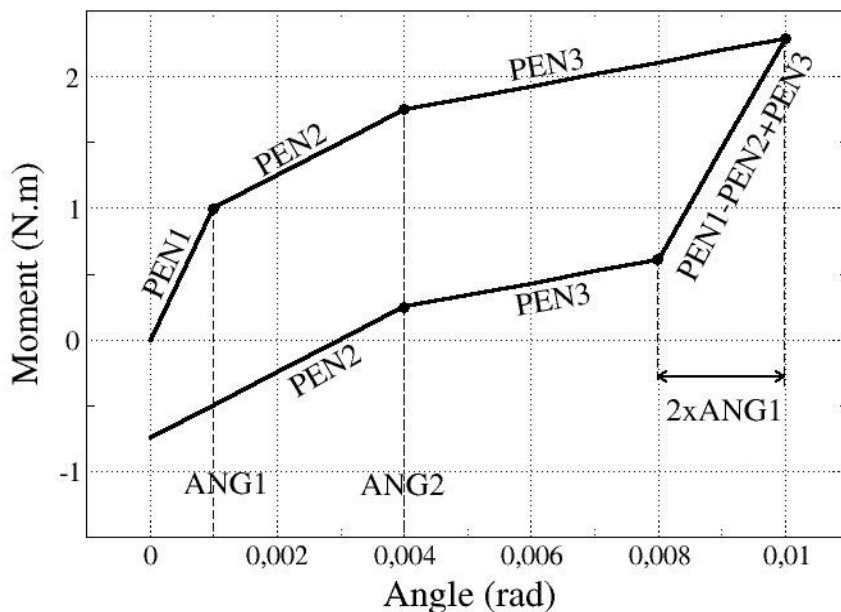

Figur Re 8.4.2-a : Court Be angle-moment on a bearing test and discharge in rotation for the law DIS_GRICRA.

8.5 Notice

The forces and moments depend on displacements and relative angles swing between the two nodes on the discrete one. One writes in this section the forces and moments with node 2, and one takes as convention of writing $\Delta \alpha = \Delta \alpha(n2) - \Delta \alpha(n1)$, which represents the “deformation” associated with the degree of freedom α for the discrete one expressed with the node $n2$. The force with the node $n1$ is equal contrary to the force to the node $n2$. It results from it that the tangent matrix is following form:

$$\underline{\underline{K}}^{\text{tan}} = \begin{pmatrix} \underline{\underline{K}} & -\underline{\underline{K}} \\ -\underline{\underline{K}} & \underline{\underline{K}} \end{pmatrix}$$

The behavior of the connection roasts pencil is different for each degree of freedom, and independent of the other degrees of freedom. It results from it that each component of the force depends only on the degree of freedom with which it is associated, and which blocks $\underline{\underline{K}}$ tangent matrix $\underline{\underline{K}}^{\text{tan}}$ are diagonal.

8.6 Use

8.6.1 Type of elements

The following characteristics of the discrete elements must be affected in the order AFPE_CARA_ELEM to be able to use DIS_GRICRA (cf document [V6.02.131]):

```
AFPE_CARA_ELEM (  
  MODELE=modele,  
  DISCRET=_F ( GROUP_MA= ('meshs'),  
               CARA = 'K_TR_L',  
               VALE = 'list of 78 terms',  
               REPERE=' LOCAL')
```

The behavior DIS_GRICRA for the connection grid-pencil can be used only with discrete elements with two nodes and 6 degrees of freedom MECA_DIS_TR_L. One must thus specify 'K_TR_L' under CARA. Contrary to the other behaviors for the discrete ones, DIS_GRICRA do not use the rigidity of discrete the data in AFPE_CARA_ELEM under the keyword VALE. Since the keyword VALE must be filled all the same, it is advised to affect a list of 78 worthless terms. In the case of a calculation of clean mode, the law of behavior DIS_GRICRA is not solicited, therefore it is then necessary to return rigidities of discrete which correspond to the elastic mode of DIS_GRICRA.

One works in the local reference mark.

```
ORIENTATION=_F ( GROUP_MA= ('meshs',),  
                CARA=' VECT_Y', GOES = vect_crayon
```

vect_crayon is a directing vector of the pencil. The direction of the pencil must imperatively be given under the keyword ORIENTATION.

In addition, the exposure field is obtained by office plurality of the lived history (stored in variable interns) and of the increment of the field introduced by the variables of orders between the step of current time and the previous moment.

8.6.2 Definition of the characteristics of material

The behavior DIS_GRICRA require the introduction of 10 parameters. These data must be provided in DEFI_MATERIAU. The parameters of entry of this law are the following:

Behavior in axial slip: 5 parameters (of which an arbitrary, purely digital parameter):

- normal rigidity of the discrete one KN_AX ;
- tangential rigidity (in the direction of the slip) KT_AX ;
- coefficient of friction of Coulomb COUL_AX ;
- gripping force F_SER (limit of slip = COUL_AX * F_SER);
- parameter of work hardening ET_AX (the law of behavior can be comparable to perfect plasticity. The parameter of work hardening is only used to ensure the convergence of calculation; a value by default of $1.0 \cdot 10^{-7}$ he is affected);

Behaviour in rotation: 6 parameters (of which a purely digital parameter)

- successive slopes PEN1, PEN2 and PEN3 curve Moment = F (angle);
- angles ANG1 and ANG2 points of inflection of the curve;
- parameter of work hardening ET_ROT (parameter being used only to ensure the convergence of calculation; a value by default of $1.0 \cdot 10^{-7}$ he is affected).

The gripping forces can vary according to Lhas temperature and irradiation. These dependences are affected on the slopes PEN1 and PEN2 for behaviour in rotation and on the gripping force F_SER for the behavior in axial slip. The functions of dependence are directly defined in the form of one FORMULA in the command file.

Names of the followed parameters by the suffix _FO allow to inform the value in the form of a function. A certain number of parameters additional, available for this behavior but which do not appear in this

document, are clarified in [V6.04.131]. The parameters of dependence in temperature and irradiation of the gripping force are defined in the document [V6.02.131].

8.6.3 Internal variables

They are 6:

- $V1$: cumulated plastic displacement (axial direction)
- $V2$: indicator of contact/friction (1 if slip, 0 so not slip)
- $V3$: indicator of separation in rotation,
- $V4$: plastic angle (slip),
- $V5$: cumulated plastic angle,
- $V6$: memorizing of the history of irradiation (fluence).

9 Behavior WEAPON

9.1 Definition

The behavior `WEAPON` is used to model the behavior of an armament of airline. The arm of each armament of broken phase, represented by a discrete element, has a non-linear behavior forces - displacement of it.

The non-linear law of behavior applies only in the local direction there and is defined by the following parameters:

- d_e displacement limits elastic range,
- d_l displacement limits plastic range,
- K_{el} slope of the elastic range,
- K_{pl} slope of the plastic range,
- K_G ultimate slope,

It connects differential displacement U_y (local reference mark) between the two nodes of the discrete element and the force with the nodes F_y (local reference mark).

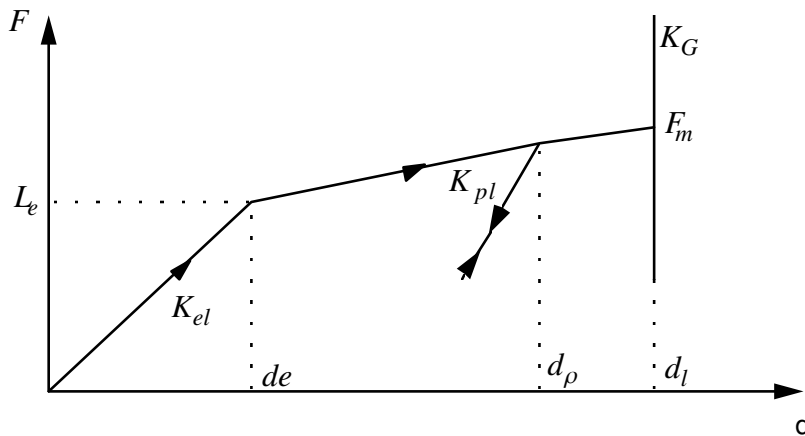

Figure 9.1-a : Behavior of the law `WEAPON`

For the three identified fields of answer, the law of behavior is expressed by:

$$\dot{F}_y = k \cdot \dot{U}_y$$

Where stiffness k vary according to the phase:

- In the phase rubber band and the phase of discharge:
 $k = K_{el}$ if $U_y < d_e$ or $U_y < d_l$ et $\Delta U_y / U_y < 0$
- In the phase plastic:
 $k = K_{pl}$ if $U_y < d_l$ et $\Delta U_y / U_y > 0$
- In the phase limit or discharge on the limiting curve:
 $k = K_G$ if $U_y > d_l$ or $V_1 \geq (d_l - d_e)$ et $\Delta U_y / U_y < 0$

Where V_1 is the internal variable corresponding to the maximum of the difference between displacement and limiting displacement $V_1 = |U_y| - d_e$.

Integration of the behavior

The integration of the law of behavior respects the following equations:

- If one is in load $\Delta U_y / U_y > 0$, one determines if one is on the elastic curve, plastic or limit, according to the value of the internal variable V_1 with the preceding step.
 - if $V_1 < (d_l - d_e)$, the new position is tested

- if $|F^-| + K_{el} |\Delta U_y| \leq K_{el} \cdot d_e$, one is on the elastic curve and thus:

$$\begin{cases} k_t = K_{el} \\ V_1^+ = V_1^- \end{cases}$$
- if $F^- + K_{el} \Delta U_y \geq K_{el} \cdot d_e$ and $U_y \leq d_l$, one is on the plastic curve and thus:

$$\begin{cases} k_t = \frac{K_{el} \cdot d_e + K_{pl} \cdot (|U_y| - d_e) - |F^-|}{|\Delta U_y|} \\ V_1^+ = |U_y| - d_e \end{cases}$$
- if $F^- + K_{el} \Delta U_y \geq K_{el} \cdot d_e$ and $U_y > d_p$, one is on the limiting curve:

$$\begin{cases} k_t = \frac{K_{el} \cdot d_e + K_{pl} \cdot d_l + K_G \cdot (|U_y| - d_l) - |F^-|}{|\Delta U_y|} \\ V_1^+ = |U_y| - d_e \end{cases}$$
- if $V_1^- \geq (d_l - d_e)$, one is on the limiting curve:

$$\begin{cases} k_t = K_G \\ V_1^+ = d_l - d_e \end{cases}$$
- If one is in discharge $\Delta U_y / U_y < 0$, one determines if one is on the elastic curve or limit, according to the value of the internal variable V_1^- with the preceding step.
 - if $V_1^- < (d_l - d_e)$, one discharges according to the elastic curve is $k_t = K_{el}$ and $V_1^+ = V_1^-$.
 - if $V_1^- \geq (d_l - d_e)$, one discharges according to the curve limits is $k_t = K_G$ and $V_1^+ = d_l - d_e$.

The force in the element is expressed then by $F^+ = F^- + k_t \Delta U_y$.

9.2 Internal variables

There is an internal variable:

- V_1 : Maximum value of the difference limiting room-displacement displacement

10 Bibliography

- [1] J.ANGLES: "Modeling of the threaded assemblies...". Note EDF/DER HI74-99-020A.
- [2] J.M.PROIX, B.QUINNEZ, P. MASSIN, P. LACLERGUE: "Fuel assemblies under irradiation. Feasibility study". Note EDF/DER HI-75/97/017/0.
- [3] G.JACQUART: "Methods of Ritz in non-linear dynamics – Application to systems with shock and friction localised" – Report EDF/DER HP61/91.105.
- [4] M.JEAN, J.J.MOREAU: "Unilaterality and dry Martini friction in the dynamics of rigid bodies collection" Proceedings of the International Mechanics Contact Symposium – ED. A. CURNIER – Polytechnic Presses and French Academics – Lausanne, 1992, pp 31-48.
- [5] J.T.ODEN, J.A.C.MARTINS: "Models and computational methods for dynamic friction phenomena" – Computational Methods Appl. Mech. Engng. 52.1992, pp 527-634.
- [6] B.BEAUFILS: "Contribution under investigation of the vibrations and the wear of the tube bundles in transverse flow" – Doctorate PARIS VI.
- [7] Fe.WAECKEL, G.DEVESA: "File of specifications of a model of shock in the order DYNA_NON_LINE Code_Aster". Note EDF/DER HP-52/97/026/B.
- [8] J.LEMAÎTRE, Mechanical J.L.CHABOCHE "of solid materials", Dunod editions, 2nd edition 2004.
- [9] W.H. CLOSE, S.A. TEUKOLSKY, W.T. VETTERLING, B.P. FLANNERY. Numerical Recipes, 2nd edition, §16.2 (Integration of Ordinary Differential Equations), Cambridge University Near, 1992.

11 History of the versions of the document

Index Doc.	Version Code_Aster	Author (S) contributor (S) organization (S)	Description of the modifications
With	5	J.M.PROIX, B.QUINNEZ EDF/R&DMMN	Initial text, laws of behavior DIS_GOUJ2E_PLAS, DIS_GOUJ2E_ELAS and DIS_CONTACT
C	7.4	G.DEVESA EDF/R & D /AMA	Addition of the law DIS_CHOC
D	8.5	V.GODARD EDF/R & D /AMA	Addition of the law DIS_GRICRWith
E	9.4	F.VOLDOIRE, J-L.FLÉJOU EDF/R & D /AMA	Addition of DIS_BILI_ELAS, DIS_ECRO_CINE, DIS_VISC, resorption of DIS_CONTACT
F	11	J-L.FLÉJOU EDF/R & D /AMA	Corrections formulas, updates compared to version 11.
G	12	F.VOLDOIRE, J-L.FLÉJOU EDF/R & D /AMA	Replacement of the model DIS_VISC.
H	13	G.DEVESA, EDF/R & D /AMA	Addition of the documentation of the law WEAPON
I	13	J-L.FLÉJOU EDF/R & D /AMA	Addition of the behavior DIS_ECRO_TRAC