Operator AFFE_CARA_ELEM

1 Goal

To assign to elements of structure of the geometrical and material characteristics. The affected geometrical data are complementary to the data of grid.

Among the treated characteristics, let us quote:

- for the elements of type hull: the thickness, a direction of reference in the tangent plan,
- for the elements of type beam: characteristics of the cross section and orientation of the main axes of inertia around neutral fibre, curve of the curved elements,
- for the elements of the discrete type (arises, mass/inertia, shock absorber): values of the matrices of rigidity, mass or damping to be affected directly or after orientation,
- for the elements of the type bars or of type cables: the surface of the cross section,
- for the elements of continuous mediums 3D and 2D: local axes by report in which the user will be able to define directions of anisotropy.

The order must be exhaustive for all the elements of structure of the model.

This operator produces a structure of the type `cara_elem`.

Contents

1 Goal.....	1
2 General syntax.....	5
3 Operands generals MODEL and VERIF.....	6
3.1 Operand MODEL.....	6
3.2 Operand VERIF.....	6
3.3 Operand INFORMATION.....	6
4 Definition of the field of assignment.....	7
4.1 Operand GROUP_MA.....	7
5 Assignment of values.....	8
6 Keyword BAR.....	10
6.1 Easily affected characteristics.....	10
6.2 Syntax.....	10
6.3 Operands.....	10
6.3.1 Operand SECTION = 'GENERAL'.....	10
6.3.2 Operand SECTION = 'CIRCLE'.....	10
6.3.3 Operand SECTION = 'RIGHT-ANGLED'.....	11
6.4 Operand 'FCX'.....	11
7 Keyword CABLE.....	12
7.1 Easily affected characteristics.....	12
7.2 Syntax.....	12
7.3 Operand 'section'.....	12
7.4 Operand 'FCX'.....	12
7.5 Operand N_INIT.....	12
8 Keyword HULL.....	13
8.1 Easily affected characteristics.....	13
8.2 Syntax.....	13
8.3 Operands.....	13
8.3.1 Operand THICK.....	13
8.3.2 Operands OFFSETTING / EXCENTREMENT_FO.....	13
8.3.3 Operands MODI_METRIQUE / COEF_RIGI_DRZ / INER_ROTA.....	14
8.3.4 Operand ANGL_REP/VECTOR.....	14
8.3.5 Operand COQUE_NCOU.....	16
8.3.6 Operand A_CIS.....	16
8.3.7 Notice on the use of ELAS_COQUE.....	16
9 Keyword BEAM.....	17
9.1 Easily affected characteristics.....	17
9.2 Syntax.....	17
9.3 Rules of use.....	18
9.4 Operands.....	19
9.4.1 Operand VARI_SECT.....	19
9.4.2 Operand MODI_METRIQUE.....	19
9.4.3 Operand SECTION = 'GENERAL'.....	20
9.4.3.1 Constant section.....	20
9.4.3.2 Homothetic section.....	21
9.4.4 Operand SECTION = 'RIGHT-ANGLED'.....	23

9.4.5 Operand SECTION = 'CIRCLE'.....	24
9.4.6 Operand SECTION = 'ELBOW'.....	25
9.4.6.1 Operand COEF_FLEX, COEF_FLEX_XZ, COEF_FLEX_XY : coefficients of flexibility.....	25
9.4.6.2 Operands INDI_SIGM, INDI_SIGM_XZ, INDI_SIGM_XY : Intensification of the constraints.....	26
9.5 Operand FCX.....	26
9.6 Operands TUYAU_NSEC / TUYAU_NCOU.....	26
10 Keyword ORIENTATION.....	27
10.1 Easily affected characteristics.....	27
10.2 Syntax.....	27
10.3 Rules of use.....	28
10.4 Operand CARA = 'ANGL_NAUT'.....	28
10.5 Operand CARA = 'VECT_X_Y'.....	30
10.6 Operand CARA = 'ANGL_VRIL'.....	30
10.7 Operand CARA = 'VECT_Y'.....	31
10.8 Operand CARA = 'GENE TUYAU'.....	31
11 Keywords MULTIFIBRE GEOM_FIBRE/.....	32
11.1 Syntax.....	32
11.2 Goal.....	32
11.3 Keyword MULTIFIBRE.....	32
11.3.1 Operands GROUP_MA.....	32
11.3.2 Operand GROUP_FIBRE.....	33
11.4 Keyword GEOM_FIBRE.....	33
11.5 Operands PREC_AIRE / PREC_INERTIE.....	33
12 Keyword DISCRETE and DISCRET_2D.....	35
12.1 Easily affected characteristics.....	35
12.2 Syntax.....	35
12.3 Operands.....	36
12.3.1 Rules of use.....	36
12.3.2 Operands VALE.....	36
12.3.3 Operands K_ (matrices of rigidity) or A_ (matrices of damping).....	37
12.3.4 Operands M_ Matrices of mass.....	41
12.3.5 Operand AMOR_HYST.....	46
12.3.6 Operand REFERENCE MARK.....	47
13 Keyword SOLID MASS.....	48
13.1 Easily affected characteristics.....	48
13.2 Syntax.....	48
13.3 Operand ANGL_REP.....	48
13.4 Operand ANGL_EULER.....	48
13.5 Operands ANGL_AXE/ORIG_AXE.....	49
13.6 Example of use.....	49
14 Keyword POUTRE_FLUI.....	50
14.1 Syntax.....	50
14.2 Easily affected characteristics.....	50
14.3 Operand GROUP_MA.....	50
14.4 Operands A_FLUI / A_CELL / COEF_ECHELLE.....	50
14.5 Operands B_T / B_N / B_TN.....	50

15 Keyword GRID.....	51
15.1 Syntax.....	51
15.2 Easily affected characteristics.....	51
15.3 Description of the operands.....	51
16 Keyword MEMBRANE.....	53
16.1 Syntax.....	53
16.2 Easily affected characteristics.....	53
16.3 Description of the operands.....	53
17 Keyword RIGI_PARASOL.....	55
17.1 Syntax.....	55
17.2 Easily affected characteristics.....	55
17.3 Description of the operands.....	56
17.4 Principle of determination of the characteristics of the discrete elements.....	56
17.5 Example of use.....	57
18 Keyword RIGI_MISS_3D.....	59
18.1 Syntax.....	59
18.2 Easily affected characteristics.....	59
18.3 Description of the operands.....	59
19 Keyword MASS_AJOU.....	60
19.1 Syntax.....	60
19.2 Easily affected characteristics.....	60
19.3 Description of the operands.....	60
20 Keyword MASS_REP.....	61
20.1 Syntax.....	61
20.2 Easily affected characteristics.....	61
20.3 Description of the operands.....	61

2 General syntax

```
will cara [cara_elem] = AFFE_CARA_ELEM (  
  ◆ MODEL = Mo [model]  
  ◇ INFORMATION = [1, 2] [defect]  
  ◇ VERIF = 'MESH',  
  
  ◆ | BAR = to see keyword BARS [$6]  
  
    | CABLE = to see keyword CABLES [$7]  
  
    | HULL = to see keyword HULL [$8]  
  
    | BEAM = to see keyword BEAM [$9]  
      ◇ ORIENTATION = to see keyword ORIENTATION [$10]  
  
    | MULTIFIBRE = to see keyword MULTI_FIBRE [$11.3]  
      ◇ GEOM_FIBRE = to see keyword GEOM_FIBRE [$11.4]  
  
    | DISCRETE = to see DISCRETE keyword [$12]  
      ◇ ORIENTATION = to see keyword ORIENTATION [$10]  
  
    | DISCRET_2D = to see keyword DISCRET_2D [$12]  
      ◇ ORIENTATION = to see keyword ORIENTATION [$10]  
  
    | SOLID MASS = to see MASSIVE keyword [$13]  
  
    | POUTRE_FLUI = to see keyword POUTRE_FLUI [$14]  
  
    | GRID = to see keyword ROASTS [$15]  
  
    | MEMBRANE = to see keyword MEMBRANE [$16]  
  
    | RIGI_PARASOL = to see keyword RIGI_PARASOL [$17]  
  
    | RIGI_MISS_3D = to see keyword RIGI_MISS_3D [$18]  
  
    | MASS_AJOU = to see keyword MASS_AJOU [$19]  
  
    | MASS_REP = to see keyword MASS_REP [$20]  
  
)
```

3 Operands generals MODEL and VERIF

3.1 Operand MODEL

◆ MODEL = Mo

Concept of the type `model`, produced by the operator `AFFE_MODELE` [U4.41.01] on which the characteristics of the elements are affected. Let us note that the model must contain explicitly at least one of the elements of structure, on which will carry the assignment (if not calculation stops).

3.2 Operand VERIF

◇ VERIF =/ 'MESH'

Argument	Significance
'MESH'	Check that the type of element supported by the meshes, to which one wants to affect a characteristic, is compatible with this characteristic (including the orientations). In the contrary case, stop with error message.

3.3 Operand INFORMATION

◇ INFORMATION Do not print anything
=/1

/ 2 Print on the file "MESSAGE", for all the elements, the list of values assigned to the elements:

- angles of orientation in degrees (beams and discrete),
- characteristics of the cross sections of beams and bars,
- impressions of the elementary matrices (discrete).

4 Definition of the field of assignment

The choice of the elements of the model M_0 to which relates the assignment is done in two stages:

- the choice of the type of element concerned with the assignment (BEAM, DISCRETE,...),
- meshes (of the type of definite element) to affect.

The choice of the keyword factor defining the type of elements (BEAM, DISCRETE, ...) imply that there exists in the model the types of adapted elements (checking carried out systematically).

The types of elements concerned depend on modeling:

- phenomenon MECHANICS

Keyword	Modeling
BAR	BAR, CABLE_GAINE
CABLE	CABLE, CABLE_POULIE
HULL	COQUE_AXIS, COQUE_C_PLAN, COQUE_D_PLAN, DKT, DST, DKQ, DSQ, Q4G, COQUE_3D, DKTG, Q4GG
DISCRETE	DIS_T, DIS_TR, 2D_DIS_T, 2D_DIS_TR
BEAM	POU_D_E, POU_D_T, POU_D_TG, POU_D_TGD, FLUI_STRU, TUYAU_3M, TUYAU_6M, POU_D_EM, POU_D_TGM
SOLID MASS	3D, AXIS, AXIS_FOURIER, C_PLAN, D_PLAN, TUYAU_3M, TUYAU_6M
GRID	GRILLE_EXCENTRE, GRILLE_MEMBRANE
MEMBRANE	MEMBRANE
POUTRE_FLUI	3D_FAISCEAU
MULTI_FIBRE	POU_D_EM, POU_D_TGM
RIGI_PARASOL	DIS_TR
RIGI_MISS_3D	DIS_T

- phenomenon THERMICS

Keyword	Modeling
HULL	COQUE_AXIS, COQUE_PLAN, HULL
SOLID MASS	3D, AXIS, PLAN

The assignment of the characteristics to the finite elements is done with the assistance DU keyword: 'GROUP_MA'.

- If VERIF is not present: in a group of meshes (or nodes), one assigns indeed the characteristics to the only elements for which they have a direction. For the other elements, the characteristics are not affected.
- If VERIF is present: one checks moreover than all the elements of the group are of the good type, if not an error message is transmitted.

4.1 Operand GROUP_MA

Operands	Significance
GROUP_MA = l _{gma}	Assignment with all the elements of the groups of meshes specified.

As in the other orders, the rule of overload applies [U1.03.00].

5 Assignment of values

Two methods are usable to affect values of characteristics:

- classical method: operand whose name evokes the treated characteristic followed by a value or a list of values. Examples:

```
HULL = _F (THICK = 1.E-2, GROUP_MA = 'G1'),
HULL = _F (ANGL_REP = (0. , 90.), GROUP_MA = 'G2'),
```
- for the assignments concerning BAR, BEAM and DISCRETE, like ORIENTATION for the elements of beam and the elements discrete, a large number of characteristics being able to be affected led to a better adapted syntax:

```
CARA = (...) # lists names of characteristics
VALE = (...) # lists values corresponding to the characteristics
```

One gives below an example to illustrate this case.

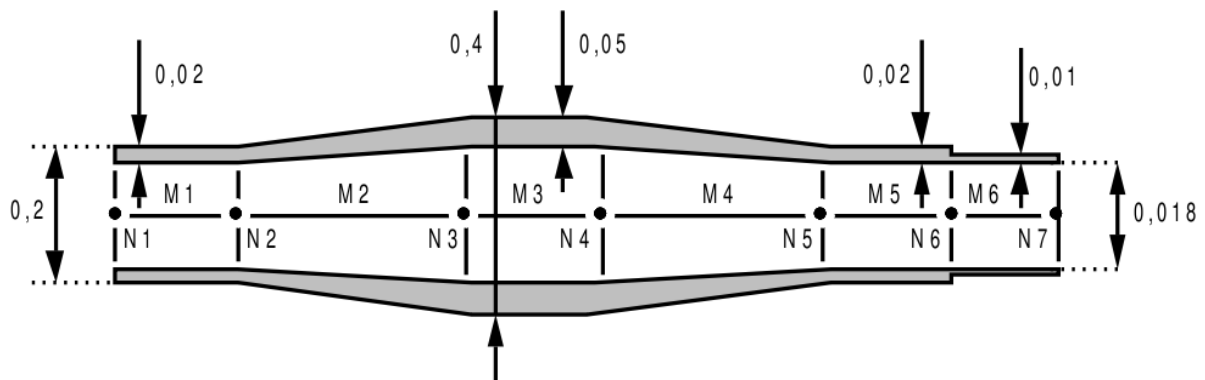

Description of the meshes:

```
SEG2
M1 N1 N2
M2 N2 N3
M3 N3 N4
M4 N5 N4
M5 N5 N6
M6 N6 N7
FINSE
```

Command file:

```
= AFFE_CARA_ELEM will cara (
  POUTRE= (
    _F (SECTION=' CERCLE', CARA= ('R', 'EP'), VALE= (0.1, 0.02),GROUP_MA= ('M1',
'M5')),
    _F (SECTION=' CERCLE', CARA= ('R', 'EP'), VALE= (0.2, 0.05),GROUP_MA= 'm3'),
    _F (SECTION=' CERCLE', CARA= ('R', 'EP'), VALE= (0.09, 0.01),GROUP_MA=
'M6'),
    _F (SECTION=' CERCLE', CARA= ('R1', 'R2'), VALE= (0.1, 0.2),GROUP_MA= ('M2',
'M4')),
    _F (SECTION=' CERCLE', CARA= ('EP1', 'EP2'), VALE= (0.02, 0.05),GROUP_MA=
('M2', 'M4')),
  ),
)
```

It is possible to use the features of the language python. The example below recovers sizes calculated by the order MACR_CARA_POUTRE, for then affecting them. The use of python requires to put PAR_LOT='NOT' in the order BEGINNING.

```
PRE_GIBI ()
SECTION = MACR_CARA_POUTRE (NOEUD= 'N1', GROUP_MA_BORD= 'EDGE')

II = 2
alpha0 = SECTION ['ALPHA', II]
cdgx0 = SECTION ['CDG_X', II]
cdgy0 = SECTION ['CDG_Y', II]
AIRE0 = SECTION ['SURFACE', II]
IY0 = SECTION ['IY_PRIN_G', II]
IZ0 = SECTION ['IZ_PRIN_G', II]
EY0 = SECTION ['EY', II]
EZ0 = SECTION ['EZ', II]
JX0 = SECTION ['CT', II]
JG0 = SECTION ['JG', II]
AY0 = SECTION ['AY', II]
AZ0 = SECTION ['AZ', II]
IYR20 = SECTION ['IYR2_PRIN_G', II]
IZR20 = SECTION ['IZR2_PRIN_G', II]

carelem=AFFE_CARA_ELEM (MODELE=mod,
  BEAM = (
    _F (GROUP_MA= ('POUT1', 'POUT2'), SECTION=' GENERALE',
      CARA= ('WITH', 'IY', 'IZ', 'AY', 'AZ', 'EY', 'EZ', 'JX', 'JG', 'IYR2', 'IZR2'),
      VALE= ( AIRE0, IY0, IZ0, AY0, AZ0, EY0, EZ0, JX0, JG0, IYR20, IZR20),),
    )
  )
```

If grid SECTION contains a surface group of mesh named 'SQUARES', it is possible to directly use the table resulting from MACR_CARA_POUTRE in the following way:

```
SECTION = MACR_CARA_POUTRE (MAILLAGE=mail, NOEUD= 'N1', GROUP_MA_BORD= 'EDGE')

carelem=AFFE_CARA_ELEM (MODELE=mod,
  BEAM = (
    _F (GROUP_MA= ('POUT1', 'POUT2'), SECTION=' GENERALE',
      TABLE_CARA=SECTION, NOM_SEC=' CARRE',
    )
  )
)
```

6 Keyword BAR

6.1 Easily affected characteristics

Allows to affect the characteristics of the cross sections of elements of the type `BAR` or `CABLE_GAINE`. One can treat three types of cross sections defined by the operand `SECTION`. With each type of section, it is possible to affect various characteristics identified by one or more names (operand `CARA`) which one associates as many values (operand `VALE`). It is also possible to give the characteristics via a table in the case of the general section, to see the documentation of the order `MACR_CARA_POUTRE`.

6.2 Syntax

```
BAR = _F (
  ♦ GROUP_MA      = lgma,                               [l_gr_maille]

  # general constant section
  ♦/SECTION       = 'GENERAL',
  ♦/TABLE_CARA   = will tb_cara,                        [sd_table]
    NOM_SEC      = nom_sec,                             [K8]
  / CARA         = 'with',
    VALE         = goes,                                [l_réel]
  # constant section right-angled
  / SECTION      = 'RIGHT-ANGLED',
  ♦ CARA         = /['H'|'EP'],
    / ['HY'|'HZ'|'EPY'|'EPZ'],
  ♦ VALE         = goes,                                [l_réel]
  # constant section rings
  / SECTION      = 'CIRCLE',
  ♦ CARA         = ['R'|'EP'],
  ♦ VALE         = goes,                                [l_réel]
  ♦ FCX         = fv,                                  [FUNCTION]
),
```

Rule of use:

One cannot overload a kind of section (`CIRCLE`, `RECTANGLE`, `GENERAL`) by another.

6.3 Operands

6.3.1 Operand `SECTION = 'GENERAL'`

The only characteristic required in this case is the surface of the cross section of the bar `'With'`. It can be read in a table (keywords `TABLE_CARA` and `NOM_SEC`, to see §9.4.3.1).

6.3.2 Operand `SECTION = 'CIRCLE'`

CARA	Significance	Value by default
R	Ray external of the tube	Obligatory
EP	Thickness in the case of a hollow tube	Full tube (EP=R)

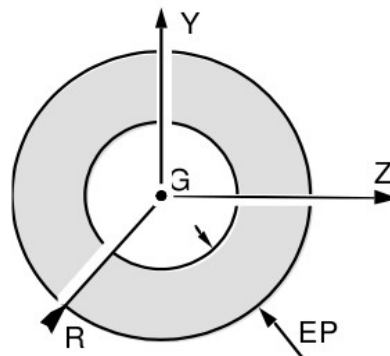

Figure 6.3.2-1 : Section of the type CIRCLE.

These values are used to calculate the surface A section.

6.3.3 Operand SECTION = 'RIGHT-ANGLED'

CARA	Significance	Value by default
/ HY	Dimension of the following rectangle GY	Obligatory
/ HZ	Dimension of the following rectangle GZ	Obligatory
/ H	Length of the edge (if the rectangle is square)	Obligatory
/ EPY	Thickness according to GY in the case of a hollow tube	HY/2
EPZ	Thickness according to GZ in the case of a hollow tube	HZ/2
/ EP	Thickness along the two axes in the case of a hollow tube	Full tube

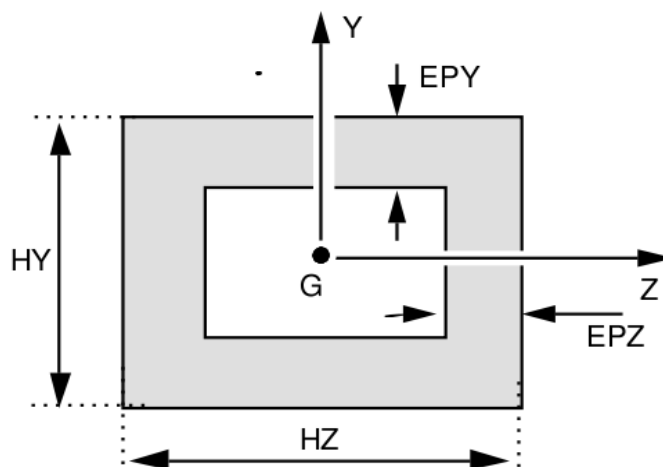

Figure 6.3.3-1 : Section of the type RECTANGLE.

Rules of use: for a given mesh

- 'H' is incompatible with 'HZ' and 'HY'
- 'EP' is incompatible with 'EPY' and 'EPZ'.

6.4 Operand 'FCX'

◇ FCX = fv

Assignment of a function describing the dependence of the force distributed with respect to the relative speed of wind (see for example [v6.02.118]).

7 Keyword CABLE

7.1 Easily affected characteristics

Allows to assign a constant section to the elements of the type cables or cable-pulley.

7.2 Syntax

```
CABLE = _F (  
  ♦ GROUP_MA      = lgma,                [l_gr_maille]  
  ♦ SECTION       = surface,              [reality]  
  ♦ FCX           = fv,                  [function]  
  ♦ N_INIT        = ninit,                [reality]  
) ,
```

7.3 Operand `\SECTION \`

♦ SECTION = surface

Allows to define the surface of the cross section of the cable.

7.4 Operand `\FCX \`

♦ FCX = fv

Assignment of a function describing the dependence of the force distributed with respect to the relative speed of wind (HM-77/01/046) to see for example test SDNL102 [V5.02.102].

7.5 Operand `N_INIT`

Allows to define the initial tension in the cable.

8 Keyword HULL

8.1 Easily affected characteristics

The characteristics which one can affect on the elements of plate or hull are:

- for all the elements of this type, a constant thickness on each mesh, since the grid represents only the average layer (or of diagram for offset),
- for all the elements of this type, the number of layers used for integration in the thickness,
- for all the elements of this type, the orientation of the specific local reference mark to each mesh,
- for certain models of hull, particular characteristics: coefficient of shearing, metric, offsetting, etc.

8.2 Syntax

```

HULL = _F (
  ♦ GROUP_MA           = lgma,                               [l_gr_maille]

  THICK ♦/             = ep,                                 [reality]
  / EPAIS_FO           = epfct                             [function]

  ◇/ANGL_REP          =/(0.0,0.0),                          [defect]
                               / (α, β),                    [l_réel]
  / VECTOR             = (vx, vy, vz),                      [l_réel]

  ◇ MODI_METRIQUE     = ['NOT'|' OUI'],                      [defect]]
  ◇ COEF_RIGI_DRZ     = KRZ (1.E-5),                        [reality (defect)]
  ◇ OFFSETTING        = E (0.0),                            [reality (defect)]
  EXCENTREMENT_FO    = efct                                 [function]

  ◇ INER_ROTA         = 'YES',
  ◇ A_CIS              = kappa (0.8333333),                 [reality (defect)]
  ◇ COQUE_NCOU        = N (1),                              [entirety (defect)]
)

```

8.3 Operands

8.3.1 Operand THICK

```

THICK ♦/             = ep
/ EPAIS_FO           = epfct

```

THICK represent the thickness of the hull which must be expressed in the same units as the coordinates of the nodes of the grid.

EPAIS_FO is a function which gives the thickness of the hull, in the same units as the coordinates of the nodes of the grid. This function depends on geometry (X, Y, Z) and is evaluated in the centre of gravity of the mesh.

8.3.2 Operands OFFSETTING / EXCENTREMENT_FO

```

◇ OFFSETTING         = / E (0.0),                          [reality (defect)]
EXCENTREMENT_FO     = efct                                 [function]

```

OFFSETTING: to define the distance enters surface with a grid and average surface, in the direction of the normal (modelings DKT, DST, GRILLE_EXCENTRE).

EXCENTREMENT_FO: Function which gives the distance between surface with a grid and average surface, in the direction of the normal (modelings DKT, DST, GRILLE_EXCENTRE). This function depends on geometry (X, Y, Z) and is evaluated in the centre of gravity of the mesh.

The taking into account of offsetting influences the behavior of inflection and possibly the behavior of membrane in the presence of coupling (there is no effect on shearing).

8.3.3 Operands MODI_METRIQUE / COEF_RIGI_DRZ / INER_ROTA

◇ MODI_METRIC = 'NOT'

Fact the assumption that the thickness of the element is low. At the time as of integrations in the thickness one does not take account of the variation of the radius of curvature (option by default for all the hulls).

◇ MODI_METRIC = 'YES'

For modelings of thick hulls: COQUE_AXIS, COQUE_C_PLAN, COQUE_D_PLAN, COQUE_3D, integrations are done by taking of account the variations of the radius of curvature according to the thickness, to see for example [R3.07.02], [R3.07.04].

◇ INER_ROTA = 'YES'

Taking into account of the inertia of rotation for modeling DKT, DST and Q4G. It is obligatory in the event of offsetting. One can omit this keyword for thin hulls, where the terms of inertia of rotation are negligible compared to different in the matrix of mass [R3.07.03].

◇ COEF_RIGI_DRZ = KRZ,

KRZ is a coefficient of fictitious rigidity (necessarily small) on the degree of freedom of rotation around the normal with the hull. It is necessary to prevent that the matrix of rigidity is singular, but must be selected smallest possible. The value by default of 10^{-5} is appropriate for most situations (it is a relative value: rigidity around the normal is equal to KRZ time the diagonal minor term of the matrix of rigidity of the element). For the DKT, there are two operating processes. COEF_RIGI_DRZ negative and COEF_RIGI_DRZ positive. In the case COEF_RIGI_DRZ positive, it degree of freedom DRZ always a direction of fictitious rotation has which prevents the matrix from being singular in the total reference mark. In the case of one COEF_RIGI_DRZ negative, one reinforces by a variational writing the kinematics of rotation of the element plates around his normal. degree of freedom DRZ thus has a physical direction. One advises a value of 10^{-8} .

Note:

Attention, in STAT/DYNA_NON_LINE, this coefficient can involve additional iterations of Newton (more than one iteration for a linear problem for example).

8.3.4 Operand ANGL_REP/VECTOR

Keywords ANGL_REP or VECTOR allow to inform to the reference mark "user" in each element of hull. It is in this reference mark that for example the constraints in the generalized hull or efforts are expressed [U2.01.05].

The user provides using these keywords a vector V who will allow to entirely define the reference mark. The construction of this reference mark "user" from V is carried out in any point P in the following way (cf Appears 8.3.4-1):

- the projection of V on the tangent level provides the axis x_l ,
- the vector z_l is colinéaire with the normal n with the plan of the hull which is known for each element, its orientation can be changed by MODI_MAILLAGE/ORIE_NORM_COQUE [U4.23.04],
- the vector y_l is built so as to have an orthonormal reference mark.

The reference mark "user" is thus: (P, x_l, y_l, z_l) with: $z_l = n$ and $y_l = z_l \wedge x_l$

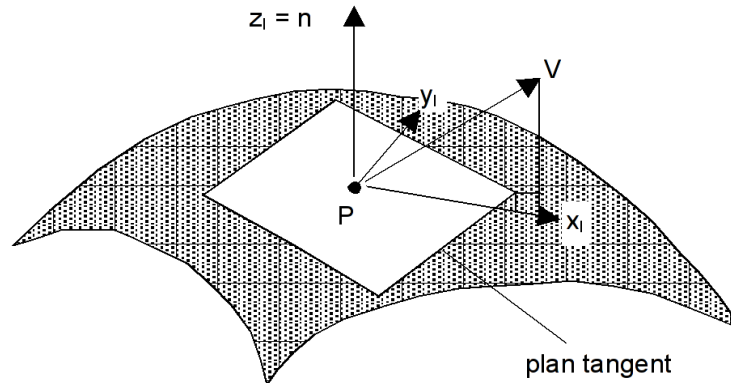

Figure 8.3.4-1: Definition of the reference mark user of a hull

Keywords ANGL_REP and VECTOR are exclusive, the vector V is defined using one or other.

◇ ANGL_REP = (α, β)

The keyword ANGL_REP the vector defines V in the total reference mark (O, X, Y, Z) starting from two nautical angles α and β as explained Figure 8.3.4-2 and Appears 8.3.4-3.

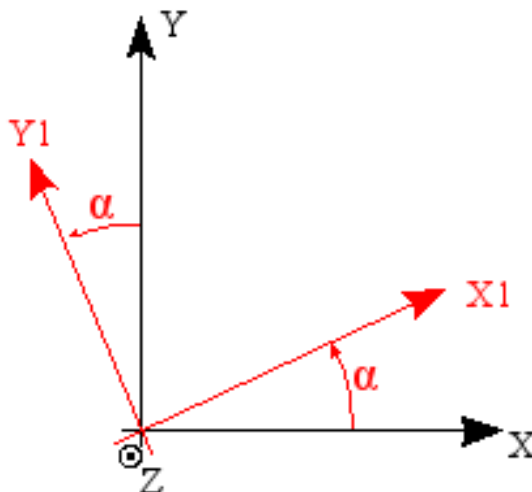

Figure 8.3.4-2 : Representation of the angle α
 Rotation α around OZ transform $(OXYZ)$ in (OX_1Y_1Z) with $Z_1 \equiv Z$.

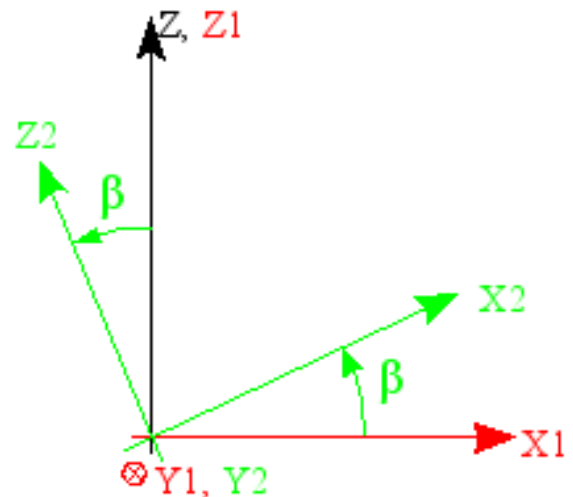

Figure 8.3.4-3 : Representation of the angle β
 Rotation β around OY_1 transform OX_1 in OX_2 . Note: on the figure the angle β is negative.

In three-dimensional representation, the vector is obtained as follows [Figure 8.3.4-4].

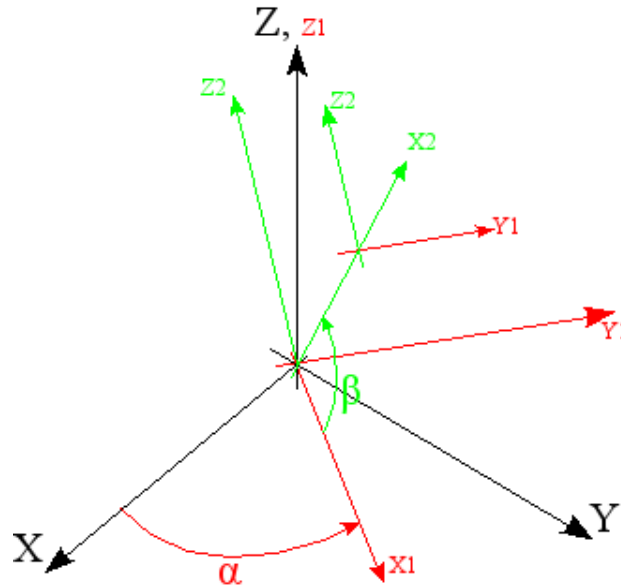

Figure 8.3.4-4 : Representation 3D of the vector V defined by `ANGL_REP`

◇ VECTOR = (vx, vy, vz)

The vector V is defined by its coordinates in the reference mark total (O, X, Y, Z).

Note:

- If none the keywords above is indicated, it is thus the total axis X who determines, by projection on the tangent level of the hull, the reference mark "user" of each mesh.
- The reference mark "user" is also used for the definition of the orientation of fibres in the composite hulls (`DEFI_COMPOSITE`, [U4.42.03]).

8.3.5 Operand COQUE_NCOU

◇ COQUE_NCOU = / N (1), [entirety, defect]

It is amongst layers used for integration in the thickness the hull. The number of layers also determines the number of under-points of the stress field: $2n+1$.

Into non-linear, it is necessary to use more than one layer to correctly integrate the constraints in the thickness, cf. [U2.02.01].

8.3.6 Operand A_CIS

◇ A_CIS = / kappa (0.8333333), [reality, defect]

This parameter is to be used if one wishes, for a thick hull to be within the framework of the model Coils-Kirchhoff. It is applicable only for modelings `COQUE_C_PLAN`, `COQUE_D_PLAN`, `COQUE_AXIS` and `COQUE_3D`. For more detail the user will refer to the note [U2.02.01].

8.3.7 Notice on the use of ELAS_COQUE

When one uses `ELAS_COQUE` Lbe stiffnesses of inflection and of membrane returned to the hand by the user in `DEFI_MATERIAU`. In it case, the thickness informed in `AFFE_CARA_ELEM` is only used to calculate the mass in dynamics and does not contribute to the stiffness.

9 Keyword BEAM

9.1 Easily affected characteristics

This keyword makes it possible to affect the characteristics of the cross sections of elements of the type **beam** (modelings `POU_D_E`, `POU_D_EM`, `POU_D_T`, `POU_D_TG`, `POU_D_TGM`, `POU_D_TGD`, `TUYAU_3M`, `TUYAU_6M`).

One can treat several types of sections defined by the operand `SECTION` :

- `GENERAL` : The mechanical characteristics are given.
- `RECTANGLE` : Dimensions of the section are given. *Code_Aster* calculate the mechanical characteristics necessary: surface, inertias,...
- `CIRCLE` : Dimensions of the section are given. *Code_Aster* calculate the mechanical characteristics necessary: surface, inertias,...
- `ELBOW` : Is used to define the coefficients of correction of inertias and amplification of the constraints if one wishes to take account of the ovalization of the section, which cannot be taken into account by the theory of the beams. The mechanical characteristics are given by `SECTION` who can take the value `GENERAL` or `RECTANGLE` or `CIRCLE`.

With each type of section, it is possible to affect various characteristics identified by one or more names (operand `CARA`) which one associates as many values (operand `VALE`). It is also possible to give the characteristics via a table in the case of the general section, to see the documentation of the order `MACR_CARA_POUTRE`.

It is possible to treat beams of constant section (name of characteristic without suffix) or of variable section (name of characteristic with suffix 1 or 2). The mode of variation of the section is defined by the keyword `VARI_SECT` (cf [§9.4.1]). One then gives the characteristics of the section to the initial node (name with suffix 1) and with the final node (name with suffix 2) ("initial" and "final" compared to the classification of the mesh support). One must also use this keyword to define the constant of torsion for modeling (`POU_D_EM`).

9.2 Syntax

```
BEAM = _F (
  ♦ GROUP_MA      = lgma,                               [l_gr_maille]
  # general section
  ♦/SECTION      = 'GENERAL',
  ◇ VARI_SECT    = ['CONSTANT', 'HOMOTHETIQUE']        [defect]
  # constant general section
  / ♦ TABLE_CARA = will tb_cara,                       [sd_table]
  ♦ NOM_SEC      = nom_sec,                             [K8]
  / ♦ CARA       = | 'A'| 'IY'| 'IZ'| 'AY'| 'AZ'| 'EY'| 'EZ',
                  | 'JX'| 'AI'| 'RY'| 'RZ'| 'RT',
                  | 'JG'| 'IYR2'| 'IZR2',
  ♦ VALE        = goes,                                 [l_réel]
  # homothetic general section
  / ♦ CARA       = | 'A1'| 'A2'| 'IY1'| 'IY2'| 'IZ1'| 'IZ2',
                  | 'JX1'| 'JX2'| 'AY1'| 'AY2'| 'AZ1'| 'AZ2',
                  | 'JG1'| 'JG2'| 'EY1'| 'EY2'| 'EZ1'| 'EZ2',
                  | 'AI1'| 'AI2'| 'RY1'| 'RY2'| 'RZ1'| 'RZ2',
                  | 'RT1'| 'RT2'| 'IYR21'| 'IZR21',
                  | 'IYR22'| 'IZR22',
  ♦ VALE        = goes,                                 [l_réel]
```

```

# section right-angled
/ SECTION          = 'RIGHT-ANGLED' ,
  ◊ VARI_SECT      = ['CONSTANT', 'HOMOTHETIQUE' 'REFINES'],      [defect]
# constant right-angled section
/ ◊ CARA          =/ |' H'|' EP',
                  / |'HY'|' HZ'|' EPY'|' EPZ',
  ◊ VALE          = goes,                                          [1_réel]
# homothetic right-angled section
/ ◊ CARA          =/ |' H1'|' H2'|' EP1'|' EP2',
                  / |' HY1'|' HZ1'|' HY2'|' HZ2',
                  |' EPY1'|' EPY2'|' EPZ1'|' EPZ2',
  ◊ VALE          = goes,                                          [1_réel]
# right-angled section closely connected
/ ◊ CARA          = |' HY'|' EPY'|' HZ1'|' EPZ1'|' HZ2'|' EPZ2',
  ◊ VALE          = goes,                                          [1_réel]

# section rings
/ SECTION          = 'CIRCLE' ,
  ◊ VARI_SECT      = ['CONSTANT', 'HOMOTHETIQUE'],                [defect]
# section circle constant
/ ◊ CARA          = |' R'|' EP',
  ◊ VALE          = goes,                                          [1_réel]
# section circle homothetic on GROUP_MA
/ ◊ CARA          = |' R_DEBUT'|' R_FIN'|' EP_DEBUT'|' EP_FIN',
  ◊ VALE          = goes,                                          [1_réel]

# section bends
/ SECTION          = 'ELBOW' ,
  ◊ / ◊ COEF_FLEX   = cflex,                                       [reality]
  / ◊ COEF_FLEX_XY = cflex_xy,                                     [reality]
  ◊ COEF_FLEX_XZ   = cflex_xz,                                     [reality]
  ◊/◊ INDI_SIGM    = isigm,                                       [reality]
  / ◊ INDI_SIGM_XY = isigm_xy,                                     [reality]
  ◊ INDI_SIGM_XZ   = isigm_xz,                                     [reality]
◊ MODI_METRIQUE   = ['YES', 'NOT'],                               [defect]
◊ TUYAU_NSEC      = nsec (16),                                     [entirety (defect)]
◊ TUYAU_NCOU      = ncou (3),                                     [entirety (dieis necessary)]
◊ FCX             = fv,                                          [function]
),

```

9.3 Rules of use

Note:

The orientation of the elements of beams is done by the keyword `ORIENTATION` [§10]. The angle of gimlet (which makes it possible to direct the transverse section of the beam around its neutral fibre) is always given to direct the main axes of the section what is not very practical, because these axes are in general unknown before the calculation of the geometrical characteristics of the section, cf. `MACR_CARA_POUTRE` [U4.42.02].

- It is possible to provide via variables python, the characteristics of the sections (general) resulting from a calculation with `MACR_CARA_POUTRE` (Cf the test `SSLL107F`).
- Various names of characteristics of the arguments of the operand `CARA` are described further for each argument of the operand `SECTION`.
- For a given mesh:
 - One cannot overload a kind of variation of section (constant or variable) by another.
 - One cannot overload a kind of section (`CIRCLE` , `RECTANGLE` , `GENERAL`) by another.
 - For the beams non-prismatic, the names with suffix 1 or 2 are incompatible with the names without suffix. Example: `A` is incompatible with `A1` and `A2` .

- H is incompatible with HZ and HY (like $H1$, $H2$, ...)
- EP is incompatible with EPY and EPZ (like $EP1$, $EP2$, ...).
- RY , RZ and RT intervene only for the calculation of the constraints.

9.4 Operands

9.4.1 Operand VARI_SECT

Allows to define the type of variation of section between the two nodes ends of the element of beam, elements `POU_D_E` and `POU_D_T` [R3.08.01].

The possibilities are:

Section	Closely connected	Homothetic
circle	not	yes
rectangle	yes (according to y)	yes
general	not	yes

- "Refines" mean that the surface of the section varies in a linear way between the two nodes. Dimensions in the direction are constant there (HY , EPY) and that in the direction z vary linearly ($HZ1$, $HZ2$, $EPZ1$, $EPZ2$).
- "Homothetic" mean that dimensions of the section vary linearly between the values given to the two nodes ends. In this case, the surface of the section evolves in a quadratic way. In the case of the circular hollow sections, so that the section is regarded as homothetic, it is necessary that $EP_{DEBUT}/R_{DEBUT} = EP_{FIN}/R_{FIN}$. In the case of not respect of homothety the solution given by *Code_Aster* is approximate [R3.08.01].

9.4.2 Operand MODI_METRIQUE

Allows to define for the elements `PIPE` the type of integration in the thickness (modelings `TUYAU_3M`, `TUYAU_6M`):

- `MODI_METRIQUE = 'NOT'` conduit to assimilate in integrations the ray to the average radius. This is thus valid for the pipes low thickness (compared to ray),
- `MODI_METRIQUE = 'YES'` imply a complete, more precise integration for thick pipings, but being able in certain cases to lead to oscillations of the solution.

9.4.3 Operand SECTION = 'GENERAL'

9.4.3.1 Constant section

CARA	Significance	Value by default
WITH	Surface of the section	Obligatory
IZ	Geometrical moment of inertia principal compared to GZ	Obligatory
IY	Geometrical moment of inertia principal compared to GY	Obligatory
AY	Coefficient of shearing in the direction GY	Obligatory if POU_D_T, POU_D_TG. 0. if POU_D_E
AZ	Coefficient of shearing in the direction GZ	idem
EY	Offsetting of the center of torsion (component of CG according to GY)	0.
EZ	Offsetting of the center of torsion (component of CG according to GZ)	0.
JX	Constant of torsion	Obligatory
RY	Distance from an external fibre measured according to y	1.
RZ	Distance from an external fibre measured according to z	1.
RT	Effective ray of torsion	1.
JG	Constant of warping (POU_D_TG, POU_D_TGM)	
IYR2	Necessary to the calculation of geometrical rigidity (POU_D_TG and POU_D_TGM)	
IZR2	Necessary to the calculation of geometrical rigidity (POU_D_TG and POU_D_TGM)	
AI	Surface of the bypass section of the fluid inside the beam.	obligatory for a modeling FLUI_STRU

In this precise case, the characteristics of section can be given by the keywords WILL TABLE_CARA and NOM_SEC instead of WILL_CARA and VALE. One can also give to TABLE_CARA a table resulting from the macro-order MACR_CARA_POUTRE while informing in the keyword NOM_SEC :

- the name of the grid given to MACR_CARA_POUTRE , if the section corresponds to all the grid.
- the name of the group of meshes to which the section corresponds.

One can also give him a table resulting from the operator LIRE_TABLE . For that the table must be in the following way defined:

NOM_SEC	With	IY	IZ	AY	AZ
SEC_1	a1	iy1	iz1	ay1	az1
SEC_2	a2	iy2	iz2	ay2	az1

The names of the columns are the names of the characteristics of the section. If a column contains nonreal values (except in the column NOM_SEC), she will be ignored. If the name of a column is not in the list of the possible characteristics she will be ignored.

In this case NOM_SEC can to take the value sec_1 or sec_2 .

9.4.3.2 Homothetic section

One defines the characteristics for each mesh, with the two nodes.

CARA	Significance	Value by default
A1 , A2	Surface of the section	Obligatory
IZ1 , IZ2	Geometrical moment of inertia principal compared to GZ	Obligatory
IY1, IY2	Geometrical moment of inertia principal compared to GY	Obligatory
AY1, AY2	Coefficient of shearing in the direction GY	Obligatory if POU_D_T, POU_D_TG. 0. if POU_D_E
AZ1, AZ2	Coefficient of shearing in the direction GZ	idem
EY1, EY2	Offsetting of the center of torsion (component of CG according to GY)	0.
EZ1, EZ2	Offsetting of the center of torsion (component of CG according to GZ)	0.
JX1, JX2	Constant of torsion	Obligatory
RY1, RY2	Distance from an external fibre measured according to y	1.
RZ1, RZ2	Distance from an external fibre measured according to z	1.
RT1, RT2	Effective ray of torsion	1.
JG1, JG2	Constant of warping (POU_D_TG)	
IYR21, IYR22	Necessary to the calculation of geometrical rigidity (POU_D_TG and POU_D_TGM)	
IZR21, IZR22	Necessary to the calculation of geometrical rigidity (POU_D_TG and POU_D_TGM)	
AI1, AI2	Surfaces of the bypass section of the fluid inside the beam.	obligatory for a modeling FLUI_STRU

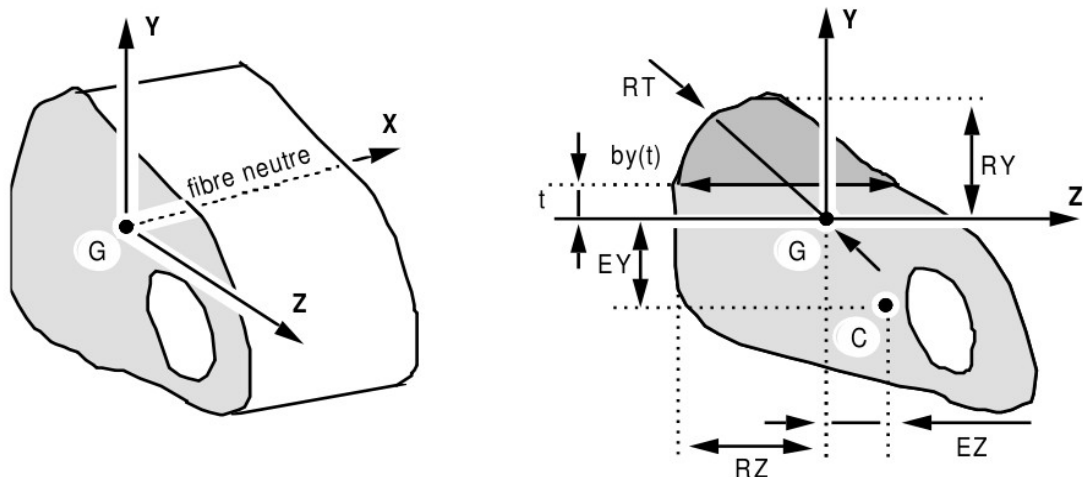

Figure 9.4.3.2-1 : Section GENERAL.

Definition of the characteristics:

$$IZ = \int_s y^2 ds$$

$$IY = \int_s z^2 ds$$

$$AY = \frac{A}{A'_y} = \frac{A}{IZ^2} \int_{y_1}^{y_2} \frac{m_y^2(y)}{b_y(y)} dy$$

$$AZ = \frac{A}{A'_z} = \frac{A}{IY^2} \int_{z_1}^{z_2} \frac{m_z^2(z)}{b_z(z)} dz$$

with $m_y(y) = \int_y^{R_y} t.b_y(t) dt$

$m_z(z) = \int_z^{R_z} t.b_z(t) dt$

$b_y(t)$ thickness according to z , in $z=t$ $b_z(t)$ thickness according to y , in $y=t$

With:

A'_y, A'_z : sheared reduced surfaces.

$$A'_y = \frac{A}{AY} \text{ with } AY \geq 1 \text{ or } A'_y = k_y A \text{ with } k_y = \frac{1}{AY} \leq 1$$

- coefficients of shearing A'_y, A'_z are used by the elements `POU_D_T`, and `POU_D_TG`, `POU_D_TGM`, for the calculation of the matrices of rigidity and mass and for the calculation of the constraints [R3.08.01]. In particular, stresses shear transverse are expressed by:

$$\tau_{xz} = \frac{V_z}{K_z A} = V_z \frac{A_z}{A} \quad \tau_{xy} = V_y \frac{A_y}{A}$$

- in the case of beams of Euler (`POU_D_E`) who do not take account of transverse shearing, one neglects the corresponding terms in the calculation of rigidity and the mass while taking $A_y = A_z = 0$. On the other hand, constraints [R3.08.01] of shearing are calculated by:

$$\tau_{xz} = \frac{V_z}{A} \quad \tau_{xy} = \frac{V_y}{A}$$

Characteristics RY, RZ, RT are used for calculation of torsion and bending stresses [R3.08.01] for the options '`SIGM_ELNO`' or '`SIPO_ELNO`' of `CALC_CHAMP` [U4.81.04].

In inflection $\sigma_{xx} = \frac{M_y}{I_y} \cdot RZ - \frac{M_z}{I_z} \cdot RY$

In torsion $\tau_{xz} = \tau_{xy} = \frac{MT}{JX} \cdot RT$

9.4.4 Operand SECTION = 'RIGHT-ANGLED'

CARA	Significance	Values by default
Constant section		
HY	Dimension of the following rectangle GY	Obligatory
HZ	Dimension of the following rectangle GZ	Obligatory
H	Dimension of the square (if the rectangle is square)	Obligatory
EPY	Thickness according to GY in the case of a hollow tube	HY/2
EPZ	Thickness according to GZ in the case of a hollow tube	HZ/2
EP	Thickness along the two axes in the case of a hollow tube	Full tube
Homothetic section		
H1, H2	Dimension of the square at each end for a variable section	H1 = H2 = H
HY1, HY2	Dimension of the following rectangle GY at each end for a variable section	HY1 = HY2 = HY
HZ1, HZ2	Dimension of the following rectangle GZ at each end for a variable section	HZ1 = HZ2 = HZ
EP1, EP2	Thickness along the two axes in the case of a hollow tube, at each end in the case of a variable section	EP1 = EP2 = EP
EPY1, EPY2	Thickness according to GY in the case of a hollow tube, at each end in the case of a variable section	EPY1 = EPY2 = EPY
EPZ1, EPZ2	Thickness according to GZ in the case of a hollow tube, at each end in the case of a variable section	EPZ1 = EPZ2 = EPZ

In the case of the rectangular hollow sections, the homothetic one can be only in the direction y [R3.08.01].

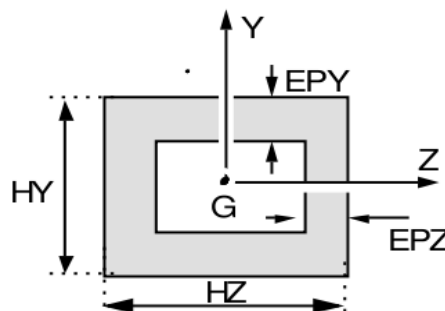

Figure 9.4.4-1 : Section RECTANGLE.

Characteristics calculated by Code_Aster are [R3.08.03]:

$$I_y = \frac{HY HZ^3}{12} - \frac{(HY - 2 EPY) \cdot (HZ - 2 EPZ)^3}{12} \quad RY = \frac{HY}{2}$$

$$I_z = \frac{HZ HY^3}{12} - \frac{(HZ - 2 EPZ)(HY - 2 EPY)^3}{12} \quad RZ = \frac{HZ}{2}$$

- If the tube is hollow:

$$JX = \frac{2 EPY EPZ (HY - EPY)^2 (HZ - EPZ)^2}{HY EPY + HZ EPZ - EPY^2 - EPZ^2}$$

$$RT = \frac{JX}{2 EPZ (HY - EPY) (HZ - EPZ)}$$

- If the tube is full, one poses:

$$a = \frac{HY}{2}, \quad b = \frac{HZ}{2} \text{ si } HY > HZ$$

$$a = \frac{HZ}{2}, \quad b = \frac{HY}{2} \text{ si } HZ > HY$$

$$J = a b^3 \left(\frac{16}{3} - 3.36 \frac{b}{a} + 0.28 \frac{b^5}{a^5} \right)$$

$$RT = \frac{J(3a + 1.8b)}{8a^2b^2}$$

- Coefficients of shearing A_y and A_z

one poses $\alpha_y = \frac{HY - 2 EPY}{HY}$ $\alpha_z = \frac{HZ - 2 EPZ}{HZ}$

Values of A_Y and A_Z are given by the table below: (Column, line)

$$A_Y = Tab(\alpha_y, \alpha_z) \quad A_Z = Tab(\alpha_z, \alpha_y)$$

	0.00	0.05	0.10	0.20	0.30	0.40	0.50	0.60	0.70	0.80	0.90	0.95
0.00	1,200	1,200	1,200	1,200	1,200	1,200	1,200	1,200	1,200	1,200	1,200	1,200
0.05	1,200	1,209	1,212	1,217	1,220	1,221	1,220	1,217	1,212	1,207	1,202	1,201
0.10	1,200	1,229	1,236	1,247	1,252	1,253	1,249	1,241	1,230	1,217	1,206	1,202
0.20	1,200	1,300	1,317	1,339	1,348	1,345	1,332	1,309	1,280	1,247	1,217	1,206
0.30	1,200	1,413	1,442	1,477	1,489	1,479	1,451	1,408	1,354	1,295	1,238	1,214
0.40	1,200	1,577	1,621	1,671	1,683	1,662	1,614	1,545	1,460	1,366	1,272	1,230
0.50	1,200	1,803	1,866	1,936	1,949	1,913	1,838	1,733	1,608	1,469	1,325	1,256
0.60	1,200	2,115	2,207	2,309	2,324	2,267	2,154	2,000	1,818	1,619	1,409	1,301
0.70	1,200	2,561	2,704	2,866	2,894	2,810	2,640	2,409	2,140	1,848	1,541	1,378
0.80	1,200	3,265	3,520	3,830	3,907	3,790	3,524	3,154	2,720	2,252	1,771	1,517
0.90	1,200	4,715	5,358	6,216	6,536	6,401	5,916	5,186	4,300	3,331	2,338	1,841
0.95	1,200	6,689	8,194	10,294	11,236	11,189	10,375	9,014	7,296	5,372	3,367	2,371

Remarks :

- The values of the table are given using a parametric study carried out with the order `MACR_CARA_POUTRE`.
- The interpolations on the values of the table are linear.
- For values of $\alpha > 0.95$, the user must calculate itself the values of the coefficients of shearing.
- The computed values can be printed with the keyword `INFORMATION = 2`.

9.4.5 Operand SECTION = 'CIRCLE'

CARA	Significance	Value by default
Constant section		
R	Ray external of the tube	Obligatory
EP	Thickness in the case of a hollow tube	Full tube (EP=R)
Affected variable section on a mesh		
R1, R2	Rays external at the two ends for a variable section	R1 = R2 = R
EP1, EP2	Thicknesses at the two ends in the case of a variable section.	EP1 = EP2 = EP
Affected variable section on a group of meshes		
R_DEBUT, R_FIN	Rays external at the two ends of the beam defined by the group of meshes	NONE
EP_DEBUT, EP_FIN	Thicknesses at the two ends of the beam defined by the group of meshes	NONE

In the case of an affected variable section on a group of meshes, the characteristics are calculated automatically starting from the values at the ends. For that the meshes must be correctly directed and contiguous in the group.

In the case of circular hollow sections, so that the section is **homothetic** it is necessary that $EP1/R1=EP2/R2$. In the case of not respect of this condition the solution given by *Code_Aster* is approximate [R3.08.01], a message of alarm is transmitted to warn the user.

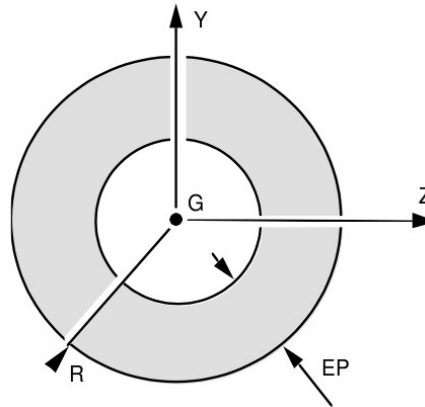

Figure 9.4.5-1 : Section CIRCLE.

Computed values by Aster are [R3.08.03]: $I_y = I_z = \frac{JX}{2} = \frac{\pi R^4}{4} - \frac{\pi (R-EP)^4}{4}$
 $RT = RY = RZ = R$

- Coefficients of shearing $Ay = Az$. with $\alpha = \frac{R-EP}{R}$

α	0.00	0.05	0.10	0.20	0.30	0.40	0.50	0.60	0.70	0.80	0.90	1.00
$Ay=Az$	1,167	1,174	1,199	1,289	1,419	1,563	1,700	1,815	1,902	1,960	1,991	2,000

Note:

- The values of the table are given using a parametric study carried out with the order *MACR_CARA_POUTRE* .
- The interpolations are linear.
- The computed values can be printed with the keyword *INFORMATION = 2* .

9.4.6 Operand SECTION = 'ELBOW'

When one wishes to take account of the coefficients of correction of flexibility or the coefficients of performance of the constraints, the modeling of the elbows must be made by modeling *POU_D_T*. To get correct results, it is advised to model an elbow of 90° with 20 to 40 meshes of *POU_D_T*. The characteristics are easily affected only on the elements *POU_D_T*.

The assignment of the mechanical characteristics (section, inertias,...) is realized by *SECTION* who can take the value *GENERAL* or *RECTANGLE* or *CIRCLE*.

9.4.6.1 Operand COEF_FLEX, COEF_FLEX_XZ, COEF_FLEX_XY : coefficients of flexibility

- ◇ $COEF_FLEX = cflex$
- ◇ $COEF_FLEX_XZ = cflex_{xz}$
- ◇ $COEF_FLEX_XY = cflex_{xy}$

For the modeling of the elbows of pipings the representation by elements of a steel ring is insufficient to represent the flexibility of a thin hull. The coefficient of flexibility corrects the geometrical data

(geometrical moments of inertia) in accordance with the rules of construction. Certain rules result in calculating rigidity of inflection with one geometrical moment of inertia corrected:

$$I_{y,z} = \frac{I_{y,z}(tube)}{cflex} \text{ with } cflex > 1.0$$

A classical value of $cflex$, for a piping thickness e and of average radius R_{moy} , is given by:

$$cflex = \frac{1.65}{\lambda} \text{ with } \lambda = \frac{e R_{courb}}{R_{moy}^2}$$

This value can be calculated directly in the command file, to see for example the test FORMA01A [V7.15.100].

If 2 coefficients are given, one obtains: $I_y = \frac{I_y(tube)}{cflex_{xy}}$, $I_z = \frac{I_z(tube)}{cflex_{xz}}$

By default, $cflex = cflex_{xz} = cflex_{xy} = 1$ (not of modification of geometrical inertias).

Note: $cflex_{xy}$ is applied to I_y , $cflex_{xz}$ is applied to I_z .

9.4.6.2 Operands INDI_SIGM, INDI_SIGM_XZ, INDI_SIGM_XY : Intensification of the constraints

- ◇ INDI_SIGM = *isigm*
- ◇ INDI_SIGM_XZ = *isigm_{xz}*
- ◇ INDI_SIGM_XY = *isigm_{xy}*

For the calculation of bending stresses in the elements of beams of tubular section, one can take account of a coefficient of intensification due to ovalization. The constraints are written then:

$$\sigma_{xx} = \frac{M_y \cdot R}{I_y} \times isigm \text{ or } \sigma_{xx} = \frac{M_z \cdot R}{I_z} \times isigm \text{ with } isigm \geq 1$$

If 2 indices are given, one a:

$$\sigma_{xx} = \frac{M_y \cdot R}{I_y} \times isigm_{xy} \text{ or } \sigma_{xx} = \frac{M_z \cdot R}{I_z} \times isigm_{xz}$$

By default, $isigm = isigm_{xz} = isigm_{xy} = 1$ (not of modification of geometrical inertias).

Note: $isigm_{xy}$ is applied to M_y , $isigm_{xz}$ is applied to M_z .

9.5 Operand FCX

- ◇ FCX = *fv*

Assignment of a function describing the dependence of the force distributed with respect to the relative speed of wind (see test SSNL118 [V6.02.118]). The loading of type wind is applicable on the elements of bar of cable and beam (modelings POU_D_E, POU_D_T, POU_D_TG, POU_D_TGD, POU_D_TGM).

9.6 Operands TUYAU_NSEC / TUYAU_NCOU

- ◇ TUYAU_NSEC = *nsec* (16) [entirety (defect)]
- ◇ TUYAU_NCOU = *ncou* (3) [entirety (defect)]

Many layers in the thickness (*ncou*, by default 3) and of sectors (*nsec*, by default 16) on the circumference used for integrations in the elements PIPE [R3.08.06]. The values by default (3 layers and 16 sectors) correspond to a necessary minimum to have a correct precision.

10 Keyword ORIENTATION

10.1 Easily affected characteristics

This keyword makes it possible to affect them **orientations**:

- main axes of the cross sections of the elements of type beam,
- **discrete elements** assigned to nodes or meshes of the type POI1 (nodal discrete elements) or with meshes of the type SEG2 (discrete elements of connection).
- position of the generator for the elements **pipes**.

Orientation of **curved beams** is defined by the key word factor DEFI_ARC.

Note:

There exists always a local reference mark by default attached to the elements of the type BEAM or DISCRETE even if the operand is not used ORIENTATION. It corresponds to ANGL_VRIL = 0 for the elements attached to a mesh SEG2 (beams or discrete) and ANGL_NAUT = (0,0,0,0) for the nodal discrete elements.

For the elements of the type PIPE, the keyword ORIENTATION allows to define a continuous generating line defining for each section the angular origin.

10.2 Syntax

```
ORIENTATION = _F (
  ♦ CARA          = ['VECT_Y'|' ANGL_VRIL'|' VECT_X_Y'|
                    'ANGL_NAUT'|' GENE_TUYAU'],
  # if CARA = 'VECT_Y'
  ♦ VALE          = vector,                               [3 realities]
  ♦ GROUP_MA     = lgma,                                  [1_gr_maille]
  ◇ PRECISION    = eps,                                   [reality]
  # if CARA = 'ANGL_VRIL'
  ♦ VALE          = angle,                                [1 reality]
  ♦ GROUP_MA     = lgma,                                  [1_gr_maille]
  ◇ PRECISION    = eps,                                   [reality]
  # if CARA = 'VECT_X_Y'
  ♦ VALE          = 2 vectors,                            [6 realities]
  ♦ GROUP_MA     = lgma,                                  [1_gr_maille]
  ◇ PRECISION    = eps,                                   [reality]
  # if CARA = 'ANGL_NAUT'
  ♦ VALE          = angles,                               [3 realities]
  ♦ GROUP_MA     = lgma,                                  [1_gr_maille]
  ◇ PRECISION    = eps,                                   [reality]
  # if CARA = 'GENE_TUYAU'
  ♦ VALE          = vector,                               [3 realities]
  ♦ GROUP_NO     = lgno,                                  [1_gr_noeud]
  ◇ CRITERION    = 'RELATIVE'|' ABSOLU'                  [defect]
  ◇ PRECISION    = eps (1.E-4),                          [reality (defect)]
)
```

10.3 Rules of use

The rule of overload is observed. L' orientation taken is the affected last.

Example:

```
ORIENTATION= (
  _F (CARA = 'ANGL_NAUT', VALE = (1.0, 1.0,1.0), GROUP_MA = 'GP1'),
  _F (CARA = 'ANGL_VRIL', VALE = 45.0,          GROUP_MA = 'GM1'),
  _F (CARA = 'ANGL_VRIL', VALE = 90.0,          GROUP_MA = 'GM2'),
)
```

- to define the local reference mark associated with a mesh of the type POI1 or a node (discrete element), it is necessary to use is ANGL_NAUT, that is to say VECT_X_Y,
- to define the local reference mark around the axis defined by a mesh SEG2 (beam or discrete), it is necessary to use is ANGL_VRIL, that is to say VECT_Y,
- to define a generating line on the elements pipe, it is necessary to use GENE_TUYAU.

10.4 Operand CARA = 'ANGL_NAUT'

♦ VALE = (α , β , γ)

Nautical angles α , β , γ provide in degrees, are the angles allowing to pass from the total reference mark of definition of the coordinates of the nodes (P, x, y, z) with the local reference mark (P, x_3, y_3, z_3) . This one is obtained by 3 rotations:

- a rotation of angle α around Z , transforming (x, y, z) in (x_1, y_1, z_1) with $z_1 \equiv z$ [Figure 10.4-1]
- a rotation of angle β around y_1 , transforming (x_1, y_1, z_1) in (x_2, y_2, z_2) with $y_2 \equiv y_1$ [Figure 10.4-2]
- a rotation of angle γ around x_2 , transforming (x_2, y_2, z_2) in (x_3, y_3, z_3) with $x_3 \equiv x_2$ [Figure 10.4-3]

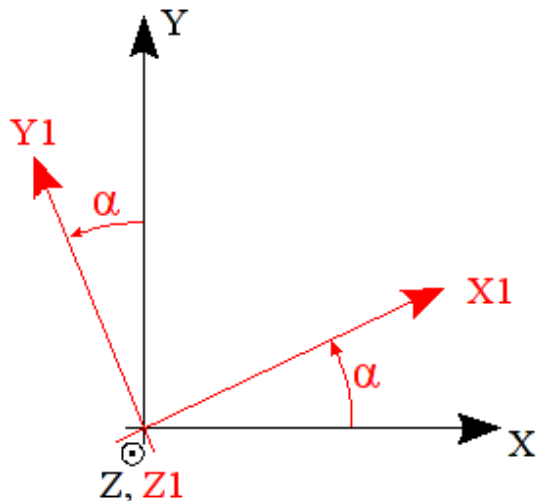

Figure 10.4-1 : angle α .

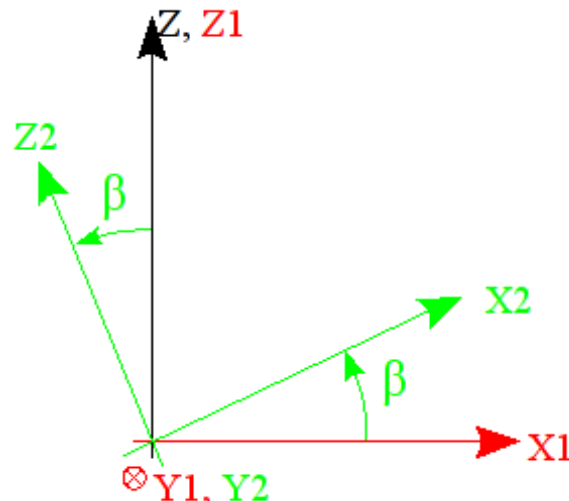

Figure 10.4-2 : angle β .

Note: for the figure 10.4-2, the swing angle β is negative.

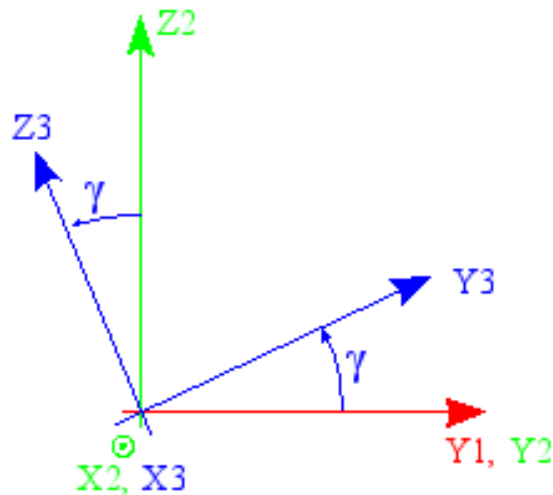

Figure 10.4-3 : angle γ .

The local reference mark is: (X_3, Y_3, Z_3)

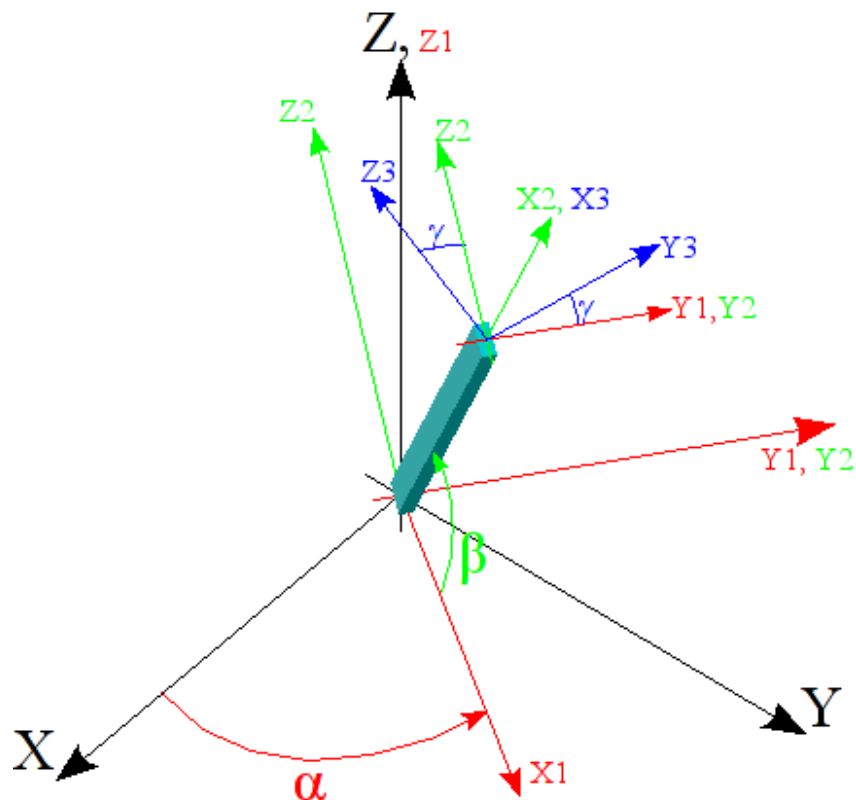

Figure 10.4-4 : Representation of the total and local reference mark.

ANGL_NAUT allows to define the local reference mark associated with a mesh of the type POI1 (for a discrete element). It is also possible to lay down the direction of a segment, but in this case, the segment must be worthless length, because if not the first 2 angles are given (cf ANGL_VRIL).

◇ PRECISION = eps

This key word allows to define the length below which the mesh is regarded as worthless size. This key word is optional and is sometimes necessary, due to the precision of the coordinates of the nodes, in the file of grid.

10.5 Operand CARA = 'VECT_X_Y'

◆ VALE = $(x_1^l, x_2^l, x_3^l, y_1^d, y_2^d, y_3^d)$

x_1^l, x_2^l, x_3^l are the 3 components, in the total reference mark, of a vector defining the local axis X_3 .
 y_1^d, y_2^d, y_3^d are the 3 components, in the total reference mark, of a vector Y^d , of which projection on the orthogonal level with X_3 will provide the local axis Y_3 . The local axis Z_3 the reference mark supplements then so that the trihedron (P, X_3, Y_3, Z_3) that is to say direct [Figure 10.5-1].

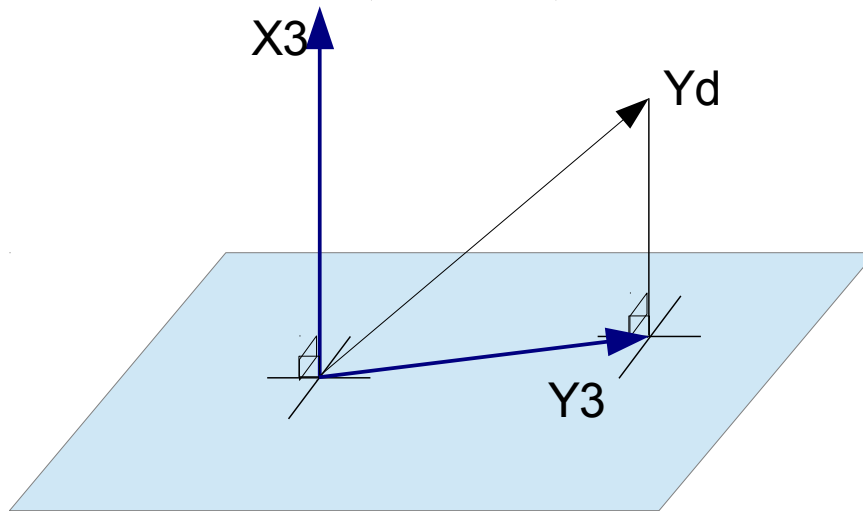

Figure 10.5-1 : Definition of VECT_X_Y.

VECT_X_Y allows to define the local reference mark associated with a mesh of the type POI1 or a node (for a discrete element). It is also possible to lay down the direction of a segment, but in this case, the segment must be worthless length, because if not the first 2 angles are given (cf ANGL_VRIL).

◆ PRECISION = /eps

This key word allows to define the length below which the mesh is regarded as worthless size. This key word is optional and is sometimes necessary, due to the precision of the coordinates of the nodes, in the file of grid.

10.6 Operand CARA = 'ANGL_VRIL'

◆ VALE = γ

In the case as of meshes SEG2, the axis x_3 is already carried by the mesh (the direction of x_3 is defined by the classification of two nodes of the mesh, it can be changed by MODI_MAILLAGE/ORIE_LIGNE, [U4.23.04]). It is thus possible to define y_3 and z_3 by rotation around x_3 .

γ is the angle (in degrees) of rotation around x_3 , transforming (P, x_3, x_2, x_2) in (P, x_3, y_3, z_3) [Figure 10.4-3].

ANGL_VRIL allows to define the local reference mark around the axis defined by a mesh SEG2 (beam or discrete). 2 angles α and β are defined by the orientation of the segment which must thus be nonworthless length.

◆ PRECISION = eps

This key word allows to define the length below which the mesh is regarded as worthless size. This key word is optional and is sometimes necessary, due to the precision of the coordinates of the nodes, in the file of grid.

10.7 Operand CARA = 'VECT_Y'

$$\diamond \text{VALE} = y_1^d, y_2^d, y_3^d$$

In the case of meshes SEG2, the axis x_3 is already carried by the mesh (the direction of x_3 is defined by the classification of two nodes of the mesh, it can be changed by MODI_MALLAGE/ORIE_LIGNE, [U4.23.04]). It is thus possible to define y_3 and z_3 by defining a vector.

y_1^d, y_2^d, y_3^d are the 3 components of a vector Y^d of which projection on the orthogonal level with x_3 will provide the local axis y_3 [Figure 10.5-1]. The axis z_3 is such as (P, x_3, y_3, z_3) that is to say direct.

VECT_Y allows to define the local reference mark around the axis defined by a mesh SEG2 (beam or discrete). 2 angles α and β are defined by the orientation of the segment which must thus be nonworthless length.

$$\diamond \text{PRECISION} = \text{eps}$$

This key word allows to define the length below which the mesh is regarded as worthless size. This key word is optional and is sometimes necessary, due to the precision of the coordinates of the nodes, in the file of grid.

10.8 Operand CARA = 'GENE TUYAU'

$$\diamond \text{VALE} = (z_1, z_2, z_3)$$

That NE concern that the elements PIPE (modelings TUYAU_3M or TUYAU_6M).

It is advisable to give the 3 components of a vector z directing the generator of the pipe (continuous line traced on the pipe, defining for each element the origin of the angle φ used to express ovalization and warping).

This vector must be defined in a node or one GROUP_NO end of the pipe. The geometry is then built automatically for all the related elements of PIPE.

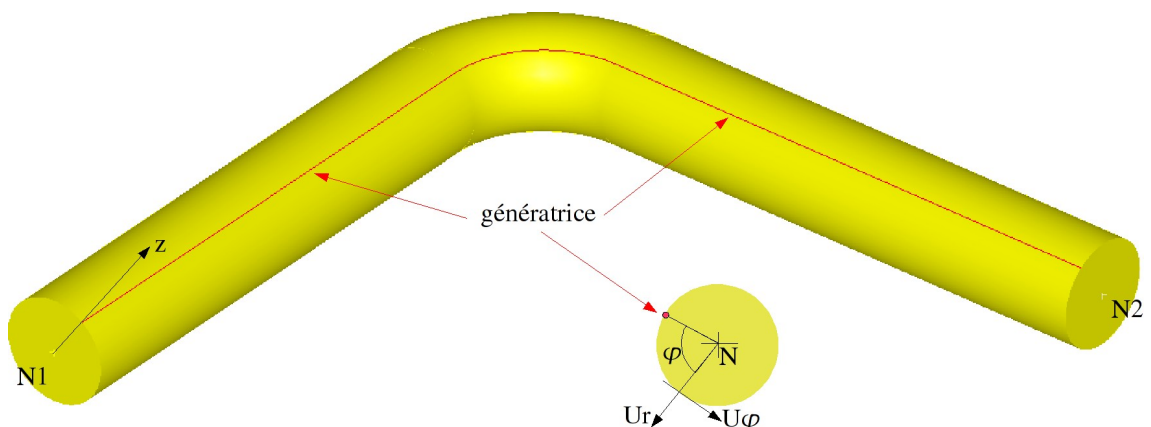

$$\diamond \text{PRECISION} = \text{eps}$$

$$\diamond \text{CRITERION} = [\text{'RELATIVE'}, \text{'ABSOLUTE'}]$$

[defect]

This precision is used for the construction of the generator like defining the limit between a right pipe section and a curved element (distinction based on the alignment of the 3 or 4 nodes of the element).

11 Keywords MULTIFIBRE GEOM_FIBRE/

11.1 Syntax

```

GEOM_FIBRE = gfibre [geom_fibre]

MULTIFIBRE = _F (
  ♦ GROUP_MA = lgrma, [l_gr_maille]
  ♦ GROUP_FIBRE = gfbr, [l_gr_fibre]
  ♦ PREC_AIRE = precis (0.01), [reality (defect)]
  ♦ PREC_INERTIE = precise (0.10), [reality (defect)]

```

Keywords used to define the section of the multifibre beams, (modélisations `POU_D_EM` or `POU_D_TGM`) while assigning to the element beam (mesh `SEG2`) groups of fibres defined using the operator `DEFI_GEOM_FIBRE` (U4-26.01).

11.2 Goal

Within the framework of a modeling of the multifibre type, there are two “levels” of modeling. There is modeling known as “longitudinal” who will be represented by a beam (geometrical support `SEG2`) and a modeling planes section (perpendicular to `SEG2`). The keyword `MULTIFIBRE` allows to associate groups of fibres (defined beforehand by the operator `DEFI_GEOM_FIBRE`) with an element beam. `GEOM_FIBRE` allows to give the name of the concept created by `DEFI_GEOM_FIBRE` containing the description of all the groups of fibres.

Note:

For the elements `POU_D_EM`, it is necessary to affect all the groups of fibres defining the cross-section on only one element beam (see R3.08.08). On the other hand for the elements `POU_D_TGM`, one can affect currently one group of fibre per element beam. If one wants to treat heterogeneous cases of section with elements `POU_D_TGM`, the operator `CREA_MALLAGE` allows to duplicate the support `SEG2` so that there is one material by support.

Caution:

The contained information in the groups of fibres make it possible to calculate some of the integrated characteristics of the cross-sections (surface, static and quadratic moments). In spite of that, for the elements `POU_D_TGM`, it is necessary to give coherent values for the operands `A`, `IY`, `IZ` under the keyword `BEAM`. A checking is carried out on the coherence of these sizes. If the relative error is too important (Confer keywords `PREC_AIRE`, `PREC_INERTIE`) a fatal error is emitted.

11.3 Keyword MULTIFIBRE

♦ MULTIFIBRE

To define the entities of the grid of beams concerned and the sections which are affected for them.

11.3.1 Operands GROUP_MA

♦ GROUP_MA

Little operand makes it possible to define the entities of the grid of beams (elements `SEG2`) who are concerned with the occurrence of the keyword factor:

Operands	Contents/Significance
<code>GROUP_MA</code>	Assignment with a list of groups of meshes

11.3.2 Operand GROUP_FIBRE

◆ GROUP_FIBRE

These operands make it possible to define the groups of fibres (among all those defined in the concept geometry of fibres given by the keyword GEOM_FIBRE) who are assigned to the elements beams of this occurrence of

11.4 Keyword GEOM_FIBRE

◆ GEOM_FIBRE

Concept created by DEFI_GEOM_FIBRE [U4.26.01], containing the description of the whole of the groups of fibres of the study.

11.5 Operands PREC_AIRE / PREC_INERTIE

◇ PREC_AIRE = precise (0.01), [reality (defect)]

◇ PREC_INERTIE = precise (0.10), [reality (defect)]

The use of the multifibre beams (POU_D_EM or POU_D_TGM) require to provide extra information, compared to the keywords VALE and CARA, under BEAM.

The objective is to check the coherence of information (SURFACE and INERTIA) provided on the one hand by the keyword BEAM and in addition by the key word MULTIFIBRE. The criterion of error is based on the error relative and is compared either with the value by default or to that given by the user via the keywords PREC_AIRE and PREC_INERTIE.

If the criterion is not satisfied a fatal error is generated. The relative error is calculated in the following way:

$$\frac{AIRE_{POUTRE} - (AIRE_{SECTION} + AIRE_{FIBRE})}{AIRE_{POUTRE}} \leq PREC_AIRE$$

$$\frac{INERTIE_{POUTRE} - (INERTIE_{SECTION} + INERTIE_{FIBRE})}{INERTIE_{POUTRE}} \leq PREC_INERTIE$$

Note:

- SURFACE (FIBRE), SURFACE (SECTION), INERTIA (SECTION), INERTIA (FIBRE) are calculated starting from the structure of data describing fibres and defined under the key word GEOM_FIBRE. This structure of data is created by order DEFI_GEOM_FIBRE [U4.26.01].
- SURFACE (FIBRE) is calculated by making the sum of the surfaces of fibres, for all the groups of fibres defined by the keyword GROUP_FIBRE operand FIBRE order DEFI_GEOM_FIBRE.
- SURFACE (SECTION) is calculated by making the sum of the surfaces of fibres defined by the key word GROUP_FIBRE of the operand SECTION order DEFI_GEOM_FIBRE.
- INERTIA (FIBRE) is calculated by making the sum of $s.d^2$ fibres defined in the whole of the groups of fibres defined by the key word GROUP_FIBRE operand FIBRE order DEFI_GEOM_FIBRE. S: represent the surface of a fibre and D the distance between fibre and the axis defined by the keyword CARA_AXE_POUTRE operand FIBRE order DEFI_GEOM_FIBRE.
- INERTIA (SECTION) is calculated by making the sum of the $s.d^2$ elements defined by the key word GROUP_FIBRE of the operand SECTION order DEFI_GEOM_FIBRE. S: represent the surface of an element and D the distance between the centre of gravity of the element and the axis defined by the keyword CARA_AXE_POUTRE operand SECTION order DEFI_GEOM_FIBRE.

Note:

When the section is defined by a grid (keyword `MAILLAGE_SECT` under the operand `SECTION` order `DEFI_GEOM_FIBRE`) the calculation of the total inertia of the whole of the surface elements does not take account of inertia suitable for each element. It is thus necessary to define a sufficient number of fibres so that this error is weak and remains lower than `PREC_INERTIE`.

For example a rectangular section cut out uniformly in the height in n elements leads to the following errors, on the values of inertias.

Cutting	2	3	4	5	6
Inertia error	25%	11.11%	6.25%	4.00%	2.77%

12 Keyword DISCRETE and DISCRET_2D

12.1 Easily affected characteristics

These keywords make it possible to assign directly to entities (meshes or nodes), which support elements of the type DIS_T, DIS_TR (DISCRETE) or 2D_DIS_T, 2D_DIS_TR (DISCRET_2D), **matrices of rigidity**, of **mass** or of **damping**.

On all the entities one can affect matrices corresponding to the degrees of freedom of translation (T) only or with the degrees of freedom of translation and rotation (TR). The matrices can be diagonal (D) or full (symmetrical or not symmetrical).

In all the cases (symmetrical, diagonal, complete matrices) **the convention of classification of the terms is imposed** :

- for symmetrical matrices, one will provide only triangular the higher, **with a convention imposed for the classification of the terms** (see examples).
- for diagonal matrices, one will provide only the terms of the diagonal, **with a convention imposed for the classification of the terms** (see examples).
- for matrices not-symmetrical, one will provide all the terms, **with a convention imposed for the classification of the terms** (see examples).

The matrices can be affected:

- with nodes or meshes of the types POI1; they are then known as nodal matrices (N),
- with meshes of the type SEG2; they are then known as matrices of connection (L).

In the event of assignment of matrices to meshes or nodes, the type of element DISCRETE must be affected, first, with these meshes or these nodes by the operator AFFE_MODELE [U4.41.01].

12.2 Syntax

```
DISCRETE and DISCRET_2D = _F (
  ◆ GROUP_MA      = lgma,                                [l_gr_maille]
  ◇ SYME          = ['YES' | 'NOT']                       [defect]
  # matrices of rigidity
  ◆ / CARA        = | 'K_T_D_N' | 'K_TR_D_N' | 'K_T_D_L' | 'K_TR_D_L',
                  | 'K_T_N' | 'K_TR_N' | 'K_T_L' | 'K_TR_L',
  # matrices of mass
  / CARA          = | 'M_T_D_N' | 'M_TR_D_N' | 'M_T_D_L' | 'M_TR_D_L'
                  | 'M_T_N' | 'M_TR_N' | 'M_T_L' | 'M_TR_L',
  # matrices of damping
  / CARA          = | 'A_T_D_N' | 'A_TR_D_N' | 'A_T_D_L' | 'A_TR_D_L',
                  | 'A_T_N' | 'A_TR_N' | 'A_T_L' | 'A_TR_L',
  ◆/VALE         = lva,                                  [l_réel]
  ◇ REFERENCE MARK      = ['LOCAL', 'TOTAL']             [defect]
  ◇ AMOR_HYST          = amnh (0.0),                     [reality (defect)]
)
```

12.3 Operands

12.3.1 Rules of use

- RIGIDITY or DAMPING and SYME = 'YES' (value by default)

CARA	CARA	ENTITY	DIS_* VALE	2D_DIS_* VALE
'K_T_D_N'	'A_T_D_N'	node or POI1	3 terms	2 terms
'K_T_D_L'	'A_T_D_L'	SEG2	3 terms	2 terms
'K_TR_D_N'	'A_TR_D_N'	node or POI1	6 terms	3 terms
'K_TR_D_L'	'A_TR_D_L'	SEG2	6 terms	3 terms
'K_T_N'	'A_T_N'	node or POI1	6 terms	3 terms
'K_T_L'	'A_T_L'	SEG2	21 terms	10 terms
'K_TR_N'	'A_TR_N'	node or POI1	21 terms	6 terms
'K_TR_L'	'A_TR_L'	SEG2	78 terms	21 terms

- RIGIDITY or DAMPING and SYME = 'NOT'

CARA	CARA	ENTITY	DIS_* VALE	2D_DIS_* VALE
'K_T_N'	'A_T_N'	node or POI1	9 terms	4 terms
'K_T_L'	'A_T_L'	SEG2	36 terms	16 terms
'K_TR_N'	'A_TR_N'	node or POI1	36 terms	9 terms
'K_TR_L'	'A_TR_L'	SEG2	144 terms	36 terms

- MASS and SYME = 'YES' (value by default)

CARA	ENTITY	DIS_* VALE	2D_DIS_* VALE
'M_T_D_N'	node or POI1	1 (mass)	1 (mass)
'M_TR_D_N'	node or POI1	10 (mass/inertia)	nonavailable
'M_T_N'	node or POI1	6 (mass/inertia)	3 (mass/inertia)
'M_T_L'	SEG2	21 (mass/inertia)	10 (mass/inertia)
'M_T_D_L'	SEG2	1 (mass/inertia)	1 (mass/inertia)
'M_TR_N'	node or POI1	21 (mass/inertia)	6 (mass/inertia)
'M_TR_D_L'	SEG2	4 (mass/inertia)	4 (mass/inertia)
'M_TR_L'	SEG2	78 (mass/inertia)	21 (mass/inertia)

- MASS and SYME = 'NOT'

CARA	ENTITY	DIS_* VALE	2D_DIS_* VALE
'M_T_N'	node or POI1	9 (mass/inertia)	4 (mass/inertia)
'M_T_L'	SEG2	36 (mass/inertia)	16 (mass/inertia)
'M_TR_N'	node or POI1	36 (mass/inertia)	9 (mass/inertia)
'M_TR_L'	SEG2	144 (mass/inertia)	36 (mass/inertia)

12.3.2 Operands VALE

◆/VALE = lva

One finds in VALE the list of the values allowing to define the elementary matrix of the discrete element. The size of this list depends on the type of element.

The keyword is used VALE if effector a standard calculation is wanted. The arguments of this keyword are realities.

12.3.3 Operands $\kappa_$ (matrices of rigidity) or $A_$ (matrices of damping)

$K_T_D_N/A_T_D_N$ and SYME = 'YES' (value by default)

for a mesh of the type POI1 or a node, one finds in correspondence in VALE 3 values k_x, k_y, k_z in DIS_T and 2 values k_x, k_y in 2D_DIS_T such as:

$$K \text{ ou } A = \begin{bmatrix} U_x & U_y & U_z \\ k_x & 0 & 0 \\ 0 & k_y & 0 \\ 0 & 0 & k_z \end{bmatrix} \qquad K \text{ ou } A = \begin{bmatrix} U_x & U_y \\ k_x & 0 \\ 0 & k_y \end{bmatrix}$$

$K_T_D_L/A_T_D_L$ and SYME = 'YES' (value by default)

for a mesh of the type SEG2, K being the matrix previously definite:

$$\begin{matrix} & \text{Noeud1} & \text{Noeud2} \\ \begin{bmatrix} K & -K \\ -K & K \end{bmatrix} \end{matrix}$$

it is thus enough to provide the 3 values k_x, k_y, k_z

$K_TR_D_N/A_TR_D_N$ and SYME = 'YES' (value by default)

for a mesh of the type POI1 or node, one finds in correspondence in VALE 6 values $k_x, k_y, k_z, k_{rx}, k_{ry}, k_{rz}$ in DIS_TR or 3 values k_x, k_y, k_{rz} in 2D_DIS_TR such as:

$$K \text{ ou } A = \begin{bmatrix} U_x & U_y & U_z & R_x & R_y & R_z \\ k_x & 0 & 0 & 0 & 0 & 0 \\ 0 & k_y & 0 & 0 & 0 & 0 \\ 0 & 0 & k_z & 0 & 0 & 0 \\ 0 & 0 & 0 & k_{rx} & 0 & 0 \\ 0 & 0 & 0 & 0 & k_{ry} & 0 \\ 0 & 0 & 0 & 0 & 0 & k_{rz} \end{bmatrix} \qquad K \text{ ou } A = \begin{bmatrix} U_x & U_y & R_z \\ k_x & 0 & 0 \\ 0 & k_y & 0 \\ 0 & 0 & k_{rz} \end{bmatrix}$$

$K_TR_D_L/A_TR_D_L$ and SYME = 'YES' (value by default)

for a mesh of the type SEG2, K being the matrix previously definite:

$$\begin{matrix} & \text{Noeud1} & \text{Noeud2} \\ \begin{bmatrix} K & -K \\ -K & K \end{bmatrix} \end{matrix}$$

it is enough to give the 6 values above.

K_T_N/A_T_N and SYME = 'YES' (value by default)

for a mesh of the type POI1 or a node, one finds in correspondence in VALE 6 values $k_1, k_2 \dots k_6$ in DIS_T or 3 values k_1, k_2, k_3 in 2D_DIS_T such as:

$$K \text{ ou } A = \begin{bmatrix} U_x & U_y & U_z \\ k_1 & k_2 & k_4 \\ & k_3 & k_5 \\ & & k_6 \end{bmatrix} \qquad K \text{ ou } A = \begin{bmatrix} U_x & U_y \\ k_1 & k_2 \\ & k_3 \end{bmatrix}$$

K_T_N/A_T_N and SYME = 'NOT'

for a mesh of the type POI1 or a node, one finds in correspondence in VALE 9 values $k_1, k_2 \dots k_9$ in DIS_T or 4 values $k_1, k_2, \dots k_4$ in 2D_DIS_T such as:

$$K \text{ ou } A = \begin{bmatrix} U_x & U_y & U_z \\ k_1 & k_4 & k_7 \\ k_2 & k_5 & k_8 \\ k_3 & k_6 & k_9 \end{bmatrix} \qquad K \text{ ou } A = \begin{bmatrix} U_x & U_y \\ k_1 & k_3 \\ k_2 & k_4 \end{bmatrix}$$

K_T_L/A_T_L and SYME = 'YES' (value by default)

for a mesh of the type SEG2, one finds in correspondence in VALE 21 values $k_1, k_2 \dots k_{21}$ in DIS_T or 10 values $k_1, k_2 \dots k_{10}$ in 2D_DIS_T and stamps it following rigidity will be affected:

$$K \text{ ou } A = \begin{bmatrix} U_{x1} & U_{y1} & U_{z1} & U_{x2} & U_{y2} & U_{z2} \\ k_1 & k_2 & k_4 & k_7 & k_{11} & k_{16} \\ & k_3 & k_5 & k_8 & k_{12} & k_{17} \\ & & k_6 & k_9 & k_{13} & k_{18} \\ & & & k_{10} & k_{14} & k_{19} \\ & & & & k_{15} & k_{20} \\ & & & & & k_{21} \end{bmatrix} \qquad K \text{ ou } A = \begin{bmatrix} U_{x1} & U_{y1} & U_{x2} & U_{y2} \\ k_1 & k_2 & k_4 & k_7 \\ & k_3 & k_5 & k_8 \\ & & k_6 & k_9 \\ & & & k_{10} \end{bmatrix}$$

K_T_L/A_T_L and SYME = 'NOT'

for a mesh of the type SEG2, one finds in correspondence in VALE 36 values $k_1, k_2 \dots k_{36}$ in DIS_T or 16 values $k_1, k_2 \dots k_{16}$ in 2D_DIS_T and stamps it following rigidity will be affected:

$$K \text{ ou } A = \begin{bmatrix} U_{x1} & U_{y1} & U_{z1} & U_{x2} & U_{y2} & U_{z2} \\ K_1 & K_7 & K_{13} & K_{19} & K_{25} & K_{31} \\ K_2 & K_8 & K_{14} & K_{20} & K_{26} & K_{32} \\ K_3 & K_9 & K_{15} & K_{21} & K_{27} & K_{33} \\ K_4 & K_{10} & K_{16} & K_{22} & K_{28} & K_{34} \\ K_5 & K_{11} & K_{17} & K_{23} & K_{29} & K_{35} \\ K_6 & K_{12} & K_{18} & K_{24} & K_{30} & K_{36} \end{bmatrix} \qquad K \text{ ou } A = \begin{bmatrix} U_{x1} & U_{y1} & U_{x2} & U_{y2} \\ k_1 & k_5 & k_9 & k_{13} \\ k_2 & k_6 & k_{10} & k_{14} \\ k_3 & k_7 & k_{11} & k_{15} \\ k_4 & k_8 & k_{12} & k_{16} \end{bmatrix}$$

K_TR_N/A_TR_N and SYME = 'YES' (value by default)

for a mesh of the type POI1 or a node, one finds in correspondence in VALE 21 values $k_1, k_2 \dots k_{21}$ in DIS_TR or 6 values $k_1, k_2 \dots k_6$ in 2D_DIS_TR such as:

$$K \text{ ou } A = \begin{bmatrix} U_x & U_y & U_z & R_x & R_y & R_z \\ k_1 & k_2 & k_4 & k_7 & k_{11} & k_{16} \\ & k_3 & k_5 & k_8 & k_{12} & k_{17} \\ & & k_6 & k_9 & k_{13} & k_{18} \\ & & & k_{10} & k_{14} & k_{19} \\ & & & & k_{15} & k_{20} \\ & & & & & k_{21} \end{bmatrix} \qquad K \text{ ou } A = \begin{bmatrix} U_x & U_y & R_z \\ k_1 & k_2 & k_4 \\ & k_3 & k_5 \\ & & k_6 \end{bmatrix}$$

K_TR_N / A_TR_N and SYME = 'NOT'

for a mesh of the type POI1 or a node, one finds in correspondence in VALE 36 values $k_1, k_2 \dots k_{36}$ in DIS_TR or 9 values $k_1, k_2 \dots k_9$ in 2D_DIS_TR such as:

$$K \text{ ou } A = \begin{bmatrix} U_x & U_y & U_z & R_x & R_y & R_z \\ k_1 & k_7 & k_{13} & k_{19} & k_{25} & k_{31} \\ k_2 & k_8 & k_{14} & k_{20} & k_{26} & k_{32} \\ k_3 & k_9 & k_{15} & k_{21} & k_{27} & k_{33} \\ k_4 & k_{10} & k_{16} & k_{22} & k_{28} & k_{34} \\ k_5 & k_{11} & k_{17} & k_{23} & k_{29} & k_{35} \\ k_6 & k_{12} & k_{18} & k_{24} & k_{30} & k_{36} \end{bmatrix} \quad K \text{ ou } A = \begin{bmatrix} U_x & U_y & R_z \\ k_1 & k_4 & k_7 \\ k_2 & k_5 & k_8 \\ k_3 & k_6 & k_9 \end{bmatrix}$$

K_TR_L / A_TR_L and SYME = 'YES' (value by default)

for a mesh of the type SEG2, one finds in correspondence in VALE 78 values $k_1, k_2 \dots k_{78}$ in DIS_TR.

$$K \text{ ou } A = \begin{bmatrix} U_{x1} & U_{y1} & U_{z1} & R_{x1} & R_{y1} & R_{z1} & U_{x2} & U_{y2} & U_{z2} & R_{x2} & R_{y2} & R_{z2} \\ k_1 & k_2 & k_4 & k_7 & k_{11} & k_{16} & k_{22} & k_{29} & k_{37} & k_{46} & k_{56} & k_{67} \\ & k_3 & k_5 & k_8 & k_{12} & k_{17} & k_{23} & k_{30} & k_{38} & k_{47} & k_{57} & k_{68} \\ & & k_6 & k_9 & k_{13} & k_{18} & k_{24} & k_{31} & k_{39} & k_{48} & k_{58} & k_{69} \\ & & & k_{10} & k_{14} & k_{19} & k_{25} & k_{32} & k_{40} & k_{49} & k_{59} & k_{70} \\ & & & & k_{15} & k_{20} & k_{26} & k_{33} & k_{41} & k_{50} & k_{60} & k_{71} \\ & & & & & k_{21} & k_{27} & k_{34} & k_{42} & k_{51} & k_{61} & k_{72} \\ & & & & & & k_{28} & k_{35} & k_{43} & k_{52} & k_{62} & k_{73} \\ & & & & & & & k_{36} & k_{44} & k_{53} & k_{63} & k_{74} \\ & & & & & & & & k_{45} & k_{54} & k_{64} & k_{75} \\ & & & & & & & & & k_{55} & k_{65} & k_{76} \\ & & & & & & & & & & k_{66} & k_{77} \\ & & & & & & & & & & & k_{78} \end{bmatrix}$$

or 21 values $k_1, k_2 \dots k_{21}$ in 2D_DIS_TR such as:

$$K \text{ ou } A = \begin{bmatrix} U_{x1} & U_{y1} & R_{z1} & U_{x2} & U_{y2} & R_{z2} \\ k_1 & k_2 & k_4 & k_7 & k_{11} & k_{16} \\ & k_3 & k_5 & k_8 & k_{12} & k_{17} \\ & & k_6 & k_9 & k_{13} & k_{18} \\ & & & k_{10} & k_{14} & k_{19} \\ & & & & k_{15} & k_{20} \\ & & & & & k_{21} \end{bmatrix}$$

K_TR_L / A_TR_L and SYME = 'NOT'

for a mesh of the type SEG2, one finds in correspondence in VALE 144 values $k_1, k_2 \dots k_{144}$ in DIS_TR.

$$K \text{ ou } A = \begin{matrix} & U_{xl} & U_{yl} & U_{zl} & R_{xl} & R_{yl} & R_{zl} & U_{x2} & U_{y2} & U_{z2} & R_{x2} & R_{y2} & R_{z2} \\ \begin{matrix} k_1 \\ k_2 \\ k_3 \\ k_4 \\ k_5 \\ k_6 \\ k_7 \\ k_8 \\ k_9 \\ k_{10} \\ k_{11} \\ k_{12} \end{matrix} & \begin{matrix} k_{13} \\ k_{14} \\ k_{15} \\ k_{16} \\ k_{17} \\ k_{18} \\ k_{19} \\ k_{20} \\ k_{21} \\ k_{22} \\ k_{23} \\ k_{24} \end{matrix} & \begin{matrix} k_{25} \\ k_{26} \\ k_{27} \\ k_{28} \\ k_{29} \\ k_{30} \\ k_{31} \\ k_{32} \\ k_{33} \\ k_{34} \\ k_{35} \\ k_{36} \end{matrix} & \begin{matrix} k_{37} \\ k_{38} \\ k_{39} \\ k_{40} \\ k_{41} \\ k_{42} \\ k_{43} \\ k_{44} \\ k_{45} \\ k_{46} \\ k_{47} \\ k_{48} \end{matrix} & \begin{matrix} k_{49} \\ k_{50} \\ k_{51} \\ k_{52} \\ k_{53} \\ k_{54} \\ k_{55} \\ k_{56} \\ k_{57} \\ k_{58} \\ k_{59} \\ k_{60} \end{matrix} & \begin{matrix} k_{61} \\ k_{62} \\ k_{63} \\ k_{64} \\ k_{65} \\ k_{66} \\ k_{67} \\ k_{68} \\ k_{69} \\ k_{70} \\ k_{71} \\ k_{72} \end{matrix} & \begin{matrix} k_{73} \\ k_{74} \\ k_{75} \\ k_{76} \\ k_{77} \\ k_{78} \\ k_{79} \\ k_{80} \\ k_{81} \\ k_{82} \\ k_{83} \\ k_{84} \end{matrix} & \begin{matrix} k_{85} \\ k_{86} \\ k_{87} \\ k_{88} \\ k_{89} \\ k_{90} \\ k_{91} \\ k_{92} \\ k_{93} \\ k_{94} \\ k_{95} \\ k_{96} \end{matrix} & \begin{matrix} k_{97} \\ k_{98} \\ k_{99} \\ k_{100} \\ k_{101} \\ k_{102} \\ k_{103} \\ k_{104} \\ k_{105} \\ k_{106} \\ k_{107} \\ k_{108} \end{matrix} & \begin{matrix} k_{109} \\ k_{110} \\ k_{111} \\ k_{112} \\ k_{113} \\ k_{114} \\ k_{115} \\ k_{116} \\ k_{117} \\ k_{118} \\ k_{119} \\ k_{120} \end{matrix} & \begin{matrix} k_{121} \\ k_{122} \\ k_{123} \\ k_{124} \\ k_{125} \\ k_{126} \\ k_{127} \\ k_{128} \\ k_{129} \\ k_{130} \\ k_{131} \\ k_{132} \end{matrix} & \begin{matrix} k_{133} \\ k_{134} \\ k_{135} \\ k_{136} \\ k_{137} \\ k_{138} \\ k_{139} \\ k_{140} \\ k_{141} \\ k_{142} \\ k_{143} \\ k_{144} \end{matrix} \end{matrix}$$

or 36 values $k_1, k_2 \dots k_{36}$ in 2D_DIS_TR such as:

$$K \text{ ou } A = \begin{matrix} & U_{xl} & U_{yl} & R_{zl} & U_{x2} & U_{y2} & R_{z2} \\ \begin{matrix} k_1 \\ k_2 \\ k_3 \\ k_4 \\ k_5 \\ k_6 \end{matrix} & \begin{matrix} k_7 \\ k_8 \\ k_9 \\ k_{10} \\ k_{11} \\ k_{12} \end{matrix} & \begin{matrix} k_{13} \\ k_{14} \\ k_{15} \\ k_{16} \\ k_{17} \\ k_{18} \end{matrix} & \begin{matrix} k_{19} \\ k_{20} \\ k_{21} \\ k_{22} \\ k_{23} \\ k_{24} \end{matrix} & \begin{matrix} k_{25} \\ k_{26} \\ k_{27} \\ k_{28} \\ k_{29} \\ k_{30} \end{matrix} & \begin{matrix} k_{31} \\ k_{32} \\ k_{33} \\ k_{34} \\ k_{35} \\ k_{36} \end{matrix} \end{matrix}$$

M_TR_N and SYME = 'NOT'

for a mesh of the type POI1 or node, one finds in correspondence in VALE 9 values M_1, M_2, \dots, M_9 in DIS_T or 4 values M_1, M_2, \dots, M_4 in 2D_DIS_T and stamps it of following mass will be affected:

$$M = \begin{bmatrix} U_x & U_y & U_z \\ M_1 & M_4 & M_7 \\ M_2 & M_5 & M_8 \\ M_3 & M_6 & M_9 \end{bmatrix} \qquad M = \begin{bmatrix} U_x & U_y \\ M_1 & M_3 \\ M_2 & M_4 \end{bmatrix}$$

M_TR_N and SYME = 'YES' (value by default)

for a mesh of the type POI1 or node, one finds in correspondence in VALE 21 values M_1, M_2, \dots, M_{21} in DIS_TR or 6 values M_1, M_2, \dots, M_6 in 2D_DIS_TR and stamps it of following mass will be affected:

$$M = \begin{bmatrix} U_x & U_y & U_z & R_x & R_y & R_z \\ M_1 & M_2 & M_4 & M_7 & M_{11} & M_{16} \\ & M_3 & M_5 & M_8 & M_{12} & M_{17} \\ & & M_6 & M_9 & M_{13} & M_{18} \\ & & & M_{10} & M_{14} & M_{19} \\ & & & & M_{15} & M_{20} \\ & & & & & M_{21} \end{bmatrix} \qquad M = \begin{bmatrix} U_x & U_y & R_z \\ M_1 & M_2 & M_4 \\ & M_3 & M_5 \\ & & M_6 \end{bmatrix}$$

M_TR_N and SYME = 'NOT'

for a mesh of the type POI1 or node, one finds in correspondence in VALE 36 values M_1, M_2, \dots, M_{36} in DIS_TR or 9 values M_1, M_2, \dots, M_9 in 2D_DIS_TR and stamps it of following mass will be affected:

$$M = \begin{bmatrix} U_x & U_y & U_z & R_x & R_y & R_z \\ M_1 & M_7 & M_{13} & M_{19} & M_{25} & M_{31} \\ M_2 & M_8 & M_{14} & M_{20} & M_{26} & M_{32} \\ M_3 & M_9 & M_{15} & M_{21} & M_{27} & M_{33} \\ M_4 & M_{10} & M_{16} & M_{22} & M_{28} & M_{34} \\ M_5 & M_{11} & M_{17} & M_{23} & M_{29} & M_{35} \\ M_6 & M_{12} & M_{18} & M_{24} & M_{30} & M_{36} \end{bmatrix} \qquad M = \begin{bmatrix} U_x & U_y & R_z \\ M_1 & M_4 & M_7 \\ M_2 & M_5 & M_8 \\ M_3 & M_6 & M_9 \end{bmatrix}$$

M_T_L and SYME = 'YES' (value by default)

for a mesh of the type SEG2, one finds in correspondence in VALE 21 values M_1, M_2, \dots, M_{21} in DIS_T or 10 values M_1, M_2, \dots, M_{10} in 2D_DIS_T and stamps it of following mass will be affected:

$$M = \begin{bmatrix} U_{x1} & U_{y1} & U_{z1} & U_{x2} & U_{y2} & U_{z2} \\ M_1 & M_2 & M_4 & M_7 & M_{11} & M_{16} \\ & M_3 & M_5 & M_8 & M_{12} & M_{17} \\ & & M_6 & M_9 & M_{13} & M_{18} \\ & & & M_{10} & M_{14} & M_{19} \\ & & & & M_{15} & M_{20} \\ & & & & & M_{21} \end{bmatrix} \quad M = \begin{bmatrix} U_{x1} & U_{y1} & U_{x2} & U_{y2} \\ M_1 & M_2 & M_4 & M_7 \\ & M_3 & M_5 & M_8 \\ & & M_6 & M_9 \\ & & & M_{10} \end{bmatrix}$$

M_T_D_L and SYME = 'YES' (value by default)

for a mesh of the type SEG2, one finds in correspondence in VALE 1 value, in DIS_T and in 2_DIS_T, the matrix of following mass will be affected:

$$M = \begin{bmatrix} \text{Noeud1} & \text{Noeud2} \\ M & \\ & M \end{bmatrix} \quad \text{the matrix } M \text{ the same definition has as that given for } M_T_D_N.$$

M_T_L and SYME = 'NOT'

for a mesh of the type SEG2, one finds in correspondence in VALE 36 values M_1, M_2, \dots, M_{36} in DIS_T or 16 values M_1, M_2, \dots, M_{16} in 2D_DIS_T and stamps it of following mass will be affected:

$$M = \begin{bmatrix} U_{x1} & U_{y1} & U_{z1} & U_{x2} & U_{y2} & U_{z2} \\ M_1 & M_7 & M_{13} & M_{19} & M_{25} & M_{31} \\ M_2 & M_8 & M_{14} & M_{20} & M_{26} & M_{32} \\ M_3 & M_9 & M_{15} & M_{21} & M_{27} & M_{33} \\ M_4 & M_{10} & M_{16} & M_{22} & M_{28} & M_{34} \\ M_5 & M_{11} & M_{17} & M_{23} & M_{29} & M_{35} \\ M_6 & M_{12} & M_{18} & M_{24} & M_{30} & M_{36} \end{bmatrix} \quad M = \begin{bmatrix} U_{x1} & U_{y1} & U_{x2} & U_{y2} \\ M_1 & M_5 & M_9 & M_{13} \\ M_2 & M_6 & M_{10} & M_{14} \\ M_3 & M_7 & M_{11} & M_{15} \\ M_4 & M_8 & M_{12} & M_{16} \end{bmatrix}$$

M_TR_L and SYME = 'YES' (value by default)

for a mesh of the type SEG2, one finds in correspondence in VALE 78 values M_1, M_2, \dots, M_{78} in DIS_TR and stamps it of following mass will be affected:

$$M = \begin{matrix} & U_{x1} & U_{y1} & U_{z1} & R_{x1} & R_{y1} & R_{z1} & U_{x2} & U_{y2} & U_{z2} & R_{x2} & R_{y2} & R_{z2} \\ \left[\begin{array}{cccccccccccc} M_1 & M_2 & M_4 & M_7 & M_{11} & M_{16} & M_{22} & M_{29} & M_{37} & M_{46} & M_{56} & M_{67} \\ & M_3 & M_5 & M_8 & M_{12} & M_{17} & M_{23} & M_{30} & M_{38} & M_{47} & M_{57} & M_{68} \\ & & M_6 & M_9 & M_{13} & M_{18} & M_{24} & M_{31} & M_{39} & M_{48} & M_{58} & M_{69} \\ & & & M_{10} & M_{14} & M_{19} & M_{25} & M_{32} & M_{40} & M_{49} & M_{59} & M_{70} \\ & & & & M_{15} & M_{20} & M_{26} & M_{33} & M_{41} & M_{50} & M_{60} & M_{71} \\ & & & & & M_{21} & M_{27} & M_{34} & M_{42} & M_{51} & M_{61} & M_{72} \\ & & & & & & M_{28} & M_{35} & M_{43} & M_{52} & M_{62} & M_{73} \\ & & & & & & & M_{36} & M_{44} & M_{53} & M_{63} & M_{74} \\ & & & & & & & & M_{45} & M_{54} & M_{64} & M_{75} \\ & & & & & & & & & M_{55} & M_{65} & M_{76} \\ & & & & & & & & & & M_{66} & M_{77} \\ & & & & & & & & & & & M_{78} \end{array} \right. \end{matrix}$$

or 21 values M_1, M_2, \dots, M_{21} in 2D_DIS_TR

$$M = \begin{matrix} & U_{x1} & U_{y1} & R_{z1} & U_{x2} & U_{y2} & R_{z2} \\ \left[\begin{array}{cccccc} M_1 & M_2 & M_4 & M_7 & M_{11} & M_{16} \\ & M_3 & M_5 & M_8 & M_{12} & M_{17} \\ & & M_6 & M_9 & M_{13} & M_{18} \\ & & & M_{10} & M_{14} & M_{19} \\ & & & & M_{15} & M_{20} \\ & & & & & M_{21} \end{array} \right. \end{matrix}$$

M_TR_D_L and SYME = 'YES' (value by default)

for a mesh of the type SEG2, one finds in correspondence in VALE 4 values $M1$, $M2$, ..., $M4$ in DIS_TR and stamps it of following mass will be affected:

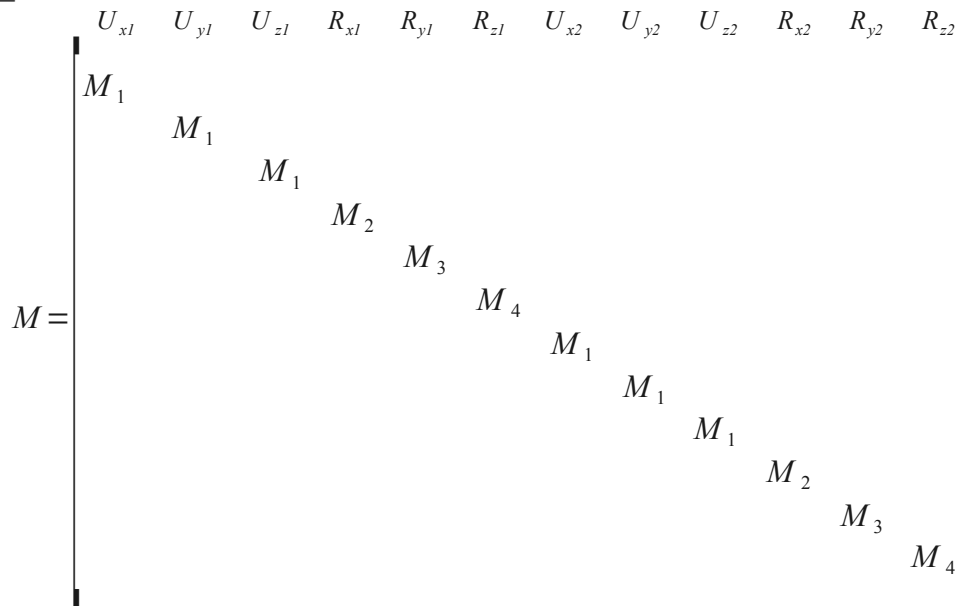

or 2 values $M1$, $M2$ in 2D_DIS_TR

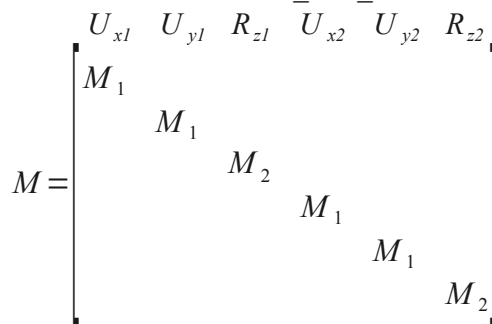

M_TR_L and SYME = 'NOT'

for a mesh of the type SEG2, one finds in correspondence in VALE 144 values M_1, M_2, \dots, M_{144} in DIS_TR and stamps it of following mass will be affected:

$$M = \begin{matrix} & U_{x1} & U_{y1} & U_{z1} & R_{x1} & R_{y1} & R_{z1} & U_{x2} & U_{y2} & U_{z2} & R_{x2} & R_{y2} & R_{z2} \\ \left[\begin{array}{l} M_1 \\ M_2 \\ M_3 \\ M_4 \\ M_5 \\ M_6 \\ M_7 \\ M_8 \\ M_9 \\ M_{10} \\ M_{11} \\ M_{12} \end{array} \right. & \left[\begin{array}{l} M_{13} \\ M_{14} \\ M_{15} \\ M_{16} \\ M_{17} \\ M_{18} \\ M_{19} \\ M_{20} \\ M_{21} \\ M_{22} \\ M_{23} \\ M_{24} \end{array} \right. & \left[\begin{array}{l} M_{25} \\ M_{26} \\ M_{27} \\ M_{28} \\ M_{29} \\ M_{30} \\ M_{31} \\ M_{32} \\ M_{33} \\ M_{34} \\ M_{35} \\ M_{36} \end{array} \right. & \left[\begin{array}{l} M_{37} \\ M_{38} \\ M_{39} \\ M_{40} \\ M_{41} \\ M_{42} \\ M_{43} \\ M_{44} \\ M_{45} \\ M_{46} \\ M_{47} \\ M_{48} \end{array} \right. & \left[\begin{array}{l} M_{49} \\ M_{50} \\ M_{51} \\ M_{52} \\ M_{53} \\ M_{54} \\ M_{55} \\ M_{56} \\ M_{57} \\ M_{58} \\ M_{59} \\ M_{60} \end{array} \right. & \left[\begin{array}{l} M_{61} \\ M_{62} \\ M_{63} \\ M_{64} \\ M_{65} \\ M_{66} \\ M_{67} \\ M_{68} \\ M_{69} \\ M_{70} \\ M_{71} \\ M_{72} \end{array} \right. & \left[\begin{array}{l} M_{73} \\ M_{74} \\ M_{75} \\ M_{76} \\ M_{77} \\ M_{78} \\ M_{79} \\ M_{80} \\ M_{81} \\ M_{82} \\ M_{83} \\ M_{84} \end{array} \right. & \left[\begin{array}{l} M_{85} \\ M_{86} \\ M_{87} \\ M_{88} \\ M_{89} \\ M_{90} \\ M_{91} \\ M_{92} \\ M_{93} \\ M_{94} \\ M_{95} \\ M_{96} \end{array} \right. & \left[\begin{array}{l} M_{97} \\ M_{98} \\ M_{99} \\ M_{100} \\ M_{101} \\ M_{102} \\ M_{103} \\ M_{104} \\ M_{105} \\ M_{106} \\ M_{107} \\ M_{108} \end{array} \right. & \left[\begin{array}{l} M_{109} \\ M_{110} \\ M_{111} \\ M_{112} \\ M_{113} \\ M_{114} \\ M_{115} \\ M_{116} \\ M_{117} \\ M_{118} \\ M_{119} \\ M_{120} \end{array} \right. & \left[\begin{array}{l} M_{121} \\ M_{122} \\ M_{123} \\ M_{124} \\ M_{125} \\ M_{126} \\ M_{127} \\ M_{128} \\ M_{129} \\ M_{130} \\ M_{131} \\ M_{132} \end{array} \right. & \left[\begin{array}{l} M_{133} \\ M_{134} \\ M_{135} \\ M_{136} \\ M_{137} \\ M_{138} \\ M_{139} \\ M_{140} \\ M_{141} \\ M_{142} \\ M_{143} \\ M_{144} \end{array} \right. \end{matrix}$$

or 36 values M_1, M_2, \dots, M_{36} in 2D_DIS_TR

$$M = \begin{matrix} & U_{x1} & U_{y1} & R_{z1} & U_{x2} & U_{y2} & R_{z2} \\ \left[\begin{array}{l} M_1 \\ M_2 \\ M_3 \\ M_4 \\ M_5 \\ M_6 \end{array} \right. & \left[\begin{array}{l} M_7 \\ M_8 \\ M_9 \\ M_{10} \\ M_{11} \\ M_{12} \end{array} \right. & \left[\begin{array}{l} M_{13} \\ M_{14} \\ M_{15} \\ M_{16} \\ M_{17} \\ M_{18} \end{array} \right. & \left[\begin{array}{l} M_{19} \\ M_{20} \\ M_{21} \\ M_{22} \\ M_{23} \\ M_{24} \end{array} \right. & \left[\begin{array}{l} M_{25} \\ M_{26} \\ M_{27} \\ M_{28} \\ M_{29} \\ M_{30} \end{array} \right. & \left[\begin{array}{l} M_{31} \\ M_{32} \\ M_{33} \\ M_{34} \\ M_{35} \\ M_{36} \end{array} \right. \end{matrix}$$

Note:

Options M_T_L, M_TR_L, M_T_D_L, M_TR_D_L do not correspond in general to an option of modeling having a mechanical meaning. They are available to import DhasNS Code_Aster Dbe matrices of masses discretized on a mesh of the type SEG2 determined prear another software. Indeed, one affects usually values of specific mass and inertia (mesh POI1) by M_T_D_N or M_TR_D_N.

12.3.5 Operand AMOR_HYST

◇ AMOR_HYST = amorh

Allows to assign to a discrete element a coefficient to build a matrix of rigidity complexes (hysteretic modeling of damping) the built matrix is:

$$(1 + j.amor_h).K$$

where K is the matrix K_* whose values are provided in the same occurrence of the keyword DISCRETE. The matrix of rigidity complexes will be actually built at the time of a call to CALC_MATR_ELEM [U4.61.01] with the option AMOR_HYST (see test SDLD313) and [R5.05.04].

12.3.6 Operand REFERENCE MARK

◇ REFERENCE MARK =/ 'LOCAL',
/ 'TOTAL',

By default the values of the matrices provided for the discrete elements are used to express the corresponding quantities in REFERENCE MARK = 'TOTAL'.

If one wishes to define a particular reference mark in a node (or nets of type POI1) one will specify REFERENCE MARK = 'LOCAL' by defining this reference mark by the keyword ORIENTATION [§10].

For a matrix defined on a mesh of the type SEG2 the operand REFERENCE MARK = 'LOCAL' allows to refer to the local reference mark attached to the mesh (initial node, final node) supplemented if necessary of an angle of gimlet defined by the keyword ORIENTATION [§10].

13 Keyword SOLID MASS

13.1 Easily affected characteristics

Allows to assign to elements 3D or 2D local axes (which can be for example used to define directions of orthotropy (cf. DEFI_MATERIAU [U4.43.01], DEFI_COMPOR [U4.43.06]). These local axes are defined by the keywords:

- ANGL_REP (3 nautical angles) or (ANGL_AXE and ORIG_AXE) or ANGL_EULER (3 angles) in 3D.
- ANGL_REP (1 only angle) in 2D.

13.2 Syntax

```
SOLID MASS = _F (
  ♦ GROUP_MA      = lgamma,                               [l_gr_maille]
  ♦/ANGL_REP      = (α, β, γ),                             [l_réel]
  / ANGL_EULER    = (Ψ, θ, φ),                             [l_réel]
  / ♦ ANGL_AXE    = (α, β),                                 [l_réel]
  ♦ ORIG_AXE     = (x1, x2, x3),                           [l_réel]
)
```

13.3 Operand ANGL_REP

α, β, γ are the 3 nautical angles (as for the keyword ORIENTATION, cf [§10]) defining the local axes (x, y, z) , which corresponds to the reference mark of orthotropy (L, T, N) . In 2D, it is necessary to only give α what defines the reference mark (LT) in the plan.

13.4 Operand ANGL_EULER

Definition of the 3 angles of Euler which make it possible to direct the local reference mark with the element. The passage of the fixed reference frame $OXYZ$ with the reference frame related to the solid $Ox_3y_3z_3$ is made by three successive rotations:

The precession Ψ , around the axis OZ , makes pass from $OXYZ$ with the reference frame $Ox_1y_1z_1$.

Nutation θ , around the axis Ox_1 , makes pass from $Ox_1y_1z_1$ with $Ox_2y_2z_2$.

Clean rotation ϕ , around the axis Oz_2 , makes pass from $Ox_2y_2z_2$ with the reference frame related to the solid $Ox_3y_3z_3$.

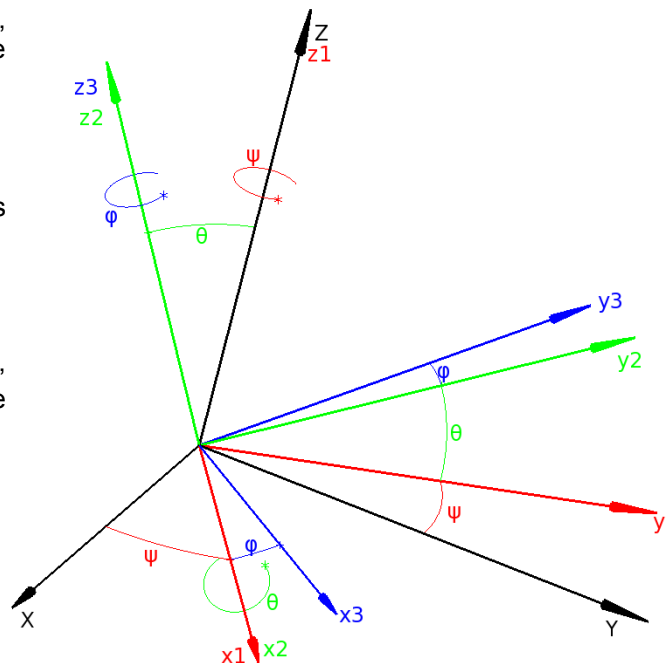

13.5 Operands ANGL_AXE/ORIG_AXE

These keywords are to be given in 3D only to define local axes for which one will use a property of symmetry of revolution, or of transverse isotropy (for example: structure with orthotropic cylindrical symmetry).

ANGL_AXE = (α, β) the axis of revolution defines $x1$, (α, β) being the first two nautical angles,

ORIG_AXE = $(x1, x2, x3)$ a point defines $O1$ axis.

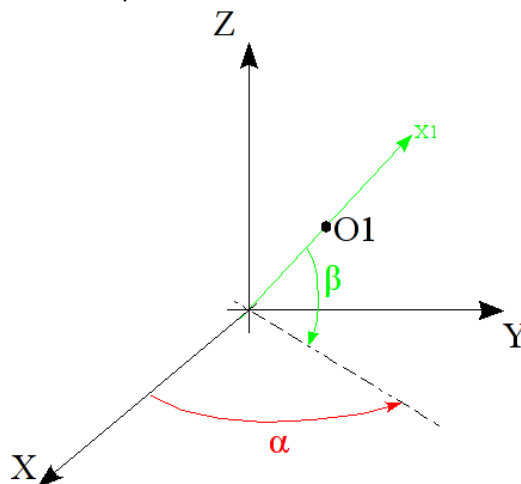

13.6 Example of use

One seeks to model a cylinder made up of a material rubber band isotropic transverse of type ELAS_ISTR, so that the axis of orthotropism of material is in the direction of the cylinder. The characteristics of such a material are to be defined in the local reference marks of the elements, with convention that the axis of orthotropism must be carried by N (cf. DEFI_MATERIAU [U4.43.01] [§3.5]).

O N can imagine two case:

- the axis of the cylinder was defined according to Z in the total reference mark. In this case, without carrying out of rotation of the local reference marks, there are by default $(X, Y, Z) = (L, T, N)$ and $N \parallel Z$ as it is wished;
- the axis of the cylinder was defined according to Y in the total reference mark. It is then necessary to carry out a rotation of the local reference marks to bring N according to Y as it is wished. One uses AFFE_CARA_ELEM (MASSIF=F (ANGLE_REP = (0., 0., -90.),),) what produces the transformation $(L, T, N) = (X, -Z, Y)$, and one has then well $N \parallel Y$.

14 Keyword POUTRE_FLUI

14.1 Syntax

```

POUTRE_FLUI = _F (
  ♦ GROUP_MA      = lgma,                [l_gr_maille]
  ♦ B_T           = BT,                  [reality]
  ♦ B_N           = bn,                  [reality]
  ♦ B_TN          = btn,                 [reality]
  ♦ A_FLUI        = aflui,               [reality]
  ♦ A_CELL        = acell,               [reality]
  ♦ COEF_ECHELLE = ech,                  [reality]
)

```

14.2 Easily affected characteristics

This keyword factor makes it possible to define the characteristics of the finite elements (hexahedron with 8 or 20 nodes) associated with modeling '3D_FAISCEAU', of the order AFFE_MODELE [U4.41.01]. This modeling relates to the representation of a periodic network of tubes bathed by an incompressible fluid [R4.07.05]. An example is given in the test SDLV111 [V2.04.111].

14.3 Operand GROUP_MA

Place of employment of the elementary characteristics:

- list of groups of meshes (keyword GROUP_MA).

14.4 Operands A_FLUI / A_CELL / COEF_ECHELLE

The periodic cell of the medium to be homogenized is two-dimensional.

The basic periodic cell which is used to calculate the homogenized coefficients is obtained by homothety starting from the real periodic cell of the medium.

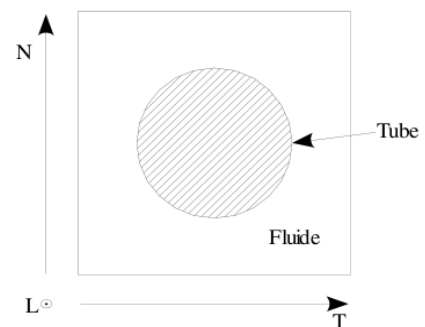

- ♦ A_FLUI : Surface of the part occupied by the fluid in the basic periodic cell
- ♦ A_CELL : Surface of the basic periodic cell
- ♦ COEF_ECHELLE : Coefficient of homothety allowing to transform the real periodic cell into the basic periodic cell

14.5 Operands B_T / B_N / B_TN

Homogenized coefficients of the problem fluid-structure calculated in the reference mark (T, N) [R4.07.05].

The orientation of this reference mark is fixed by the keyword factor ORIENTATION. Direction L is inevitably parallel to the beam axis of tubes.

15 Keyword GRID

15.1 Syntax

```

GRID = _F (
  ♦ GROUP_MA           = lgma,                [l_gr_maille]
  ♦ /SECTION           = S1,                  [reality]
  / SECTION_FO        = S1fct                 [function]
  ♦ /ANGL_REP          = (  $\alpha$ ,  $\beta$  )    [l_réel]
  / AXIS              = (vx, vy, vz)         [l_réel]
  ♦ /OFFSETTING       = ez,                  [reality]
  / EXCENTREMENT_FO  = ezfct                 [function]
  ♦ COEF_RIGI_DRZ    = kz (1.E-10),         [reality (defect)]
)

```

15.2 Easily affected characteristics

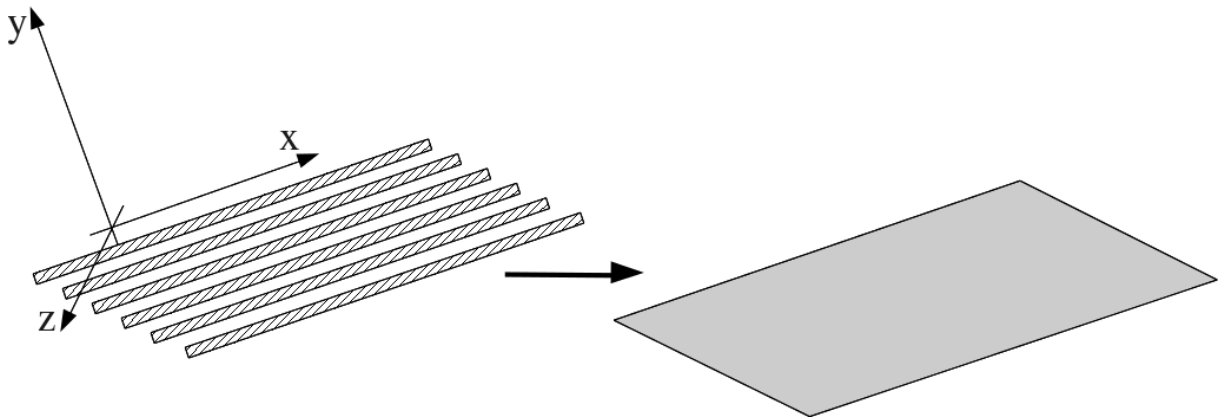

Figure 15.2-1 : replacement of the reinforcements by an equivalent tablecloth

Allows to define characteristics of a tablecloth characterized by a rigidity in only one direction, used in particular to model tablecloths of reinforcements in the reinforced concrete hulls, (see for example the test SSNS100 [V6.05.100]), affected with modelings `GRILLE_EXCENTRE` or `GRILLE_MEMBRANE`. To describe a “lattice” of reinforcements, it is enough to superimpose two elements `GRILLE_EXCENTRE` or `GRILLE_MEMBRANE` whose orientations (and thus rigidities) are orthogonal (see example in the following paragraph).

15.3 Description of the operands

The following geometrical data are necessary to model the tablecloth of reinforcements:

```

♦ /SECTION           =  $S_1$ 
  / SECTION_FO      = S1fct

```

`SECTION` : section of the reinforcements in direction 1, by unit of length. It thus corresponds to the section cumulated over a width unit. If there is a section s all them $1/5^{\text{ème}}$ of unit, the cumulated section is $5 \times s$.

`SECTION_FO` : function giving the section of the reinforcements in direction 1, by unit of length. It thus corresponds to the section cumulated over a width unit. This function depends on the geometry (X, Y, Z) and is evaluated in the centre of gravity of the mesh.

```
◇/OFFSETTING = ez  
/ EXCENTREMENT_F0 = ezfct
```

OFFSETTING : value of offsetting e_z (constant for all the nodes of the mesh) of the tablecloth of reinforcements compared to the mesh support (distance measured on the normal of the mesh support), (modeling GRILLE_EXCENTRE only).

EXCENTREMENT_F0 : function which gives the offsetting (constant for all the nodes of the mesh) of the tablecloth of reinforcements compared to the mesh support (distance measured on the normal of the mesh support), (modeling GRILLE_EXCENTRE only). This function depends on geometry (X, Y, Z) and is evaluated in the centre of gravity of the mesh.

◇ COEF_RIGI_DRZ = to see keyword HULL [§8].

◇/ANGL_REP = to see keyword HULL [§8].

This keyword makes it possible to define the reference axis (x_1) . It defines also the reference mark in which the deformations are calculated, constraints, curves, etc.

```
/ AXIS = (vx, vy, vz)
```

Just like ANGL_REP, this keyword makes it possible to fix the local reference mark of the element. The projection of the vector indicated via the keyword AXIS the vector defines y room, whereas ANGL_REP determine the vector x room.

For example, in the case of a cylindrical geometry, it makes it possible to define the directions of the reinforcements in a circumferential way.

To define a grid containing of the reinforcements in the longitudinal direction and the transverse direction, it is necessary to create two layers of elements (order CREA_MALLAGE, keyword CREA_GROUP_MA), a layer of element for the longitudinal direction and a second layer of elements for the transverse direction:

```
GRILLE= (  
  _F (GROUP_MA = 'GEOL',  
      SECTION = 0.02,  
      ANGL_REP = (0.0, 0.0, ),  
      OFFSETTING = 0.0,  
  ),  
  _F (GROUP_MA = 'GEOT',  
      SECTION = 0.01,  
      ANGL_REP = (90.0, 0.0, ),  
      OFFSETTING = 0.01,  
  ),  
)
```

16 Keyword MEMBRANE

16.1 Syntax

```
MEMBRANE= _F (
  ♦ GROUP_MA = lgma, [l_gr_maille]
  ♦ / THICK = ep [reality]
  ◇/ANGL_REP = (  $\alpha$ ,  $\beta$  ) [l_R]
  / AXIS = (vx, vy, vz) [l_R]
  ◇/N_INIT =/ ninit [reality]
  / 0. [defect]
)
```

16.2 Easily affected characteristics

One distinguishes two behavior for the membrane. ON has of a linear behavior for the small deformations and a nonlinear behavior for the great deformations.

For the linear behavior:

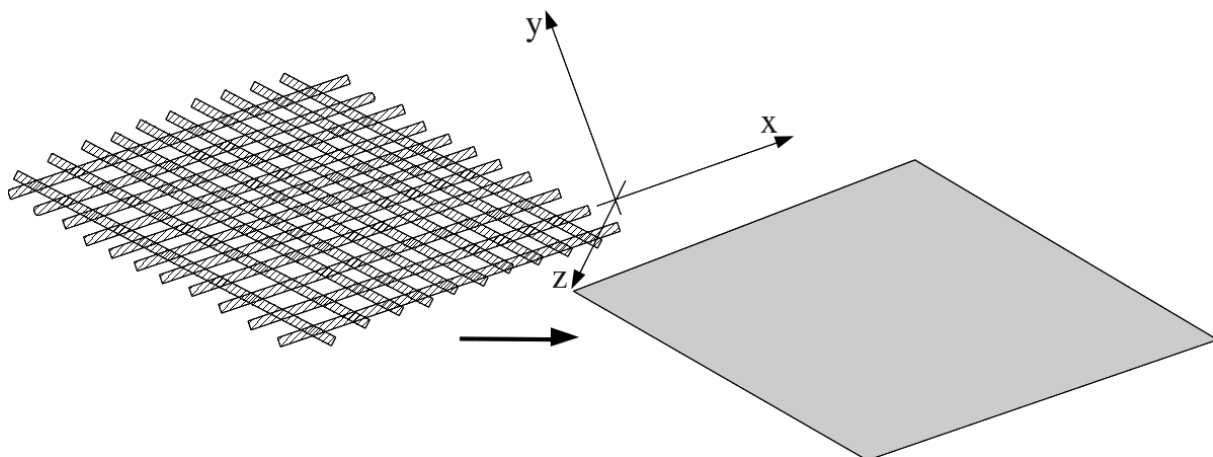

Figure 16.2-1: replacement of the reinforcements by a membrane

The keyword `MEMBRANE` allows to define characteristics of an anisotropic tablecloth when modeling `MEMBRANE`, is used (see for example the test `SSLS138 [V3.03.138]`). It can in particular be used to model elastic tablecloths of reinforcements in the reinforced concrete hulls. This modeling can be associated with elements with interface to model the decoherence of this tablecloth. The rigidity of this membrane is indicated under `DEFI_MATERIAU/ELAS_MEMBRANE`, cf. `[U4.43.01]`.

For the nonlinear behavior:

The keyword `MEMBRANE` allows to define characteristics of an isotropic membrane when modeling `MEMBRANE`, is used (see for example the test `SSNS115A [V6.05.115]`). The rigidity and the Poisson's ratio of this membrane are indicated under `DEFI_MATERIAU/ELAS` and the law of behavior under `STAT_NON_LINE/RELATION/ELAS_MEMBRANE_SV` or `ELAS_MEMBRANE_NH [U4.51.11]`. One has only two laws of behaviors very-rubber bands: the law of Coming Saint – Kirchhoff and the law Néo-Hookéenne.

16.3 Description of the operands

THICK \diamond / = ep

THICK represent the thickness of the membrane who must be expressed in the same units as the coordinates of the nodes of the grid. This thickness is not taken into account in small deformations and thus affects only with one nonlinear behavior.

\diamond / ANGL_REP = to see keyword HULL [§8].

With a linear behavior, this keyword defines the local reference mark related to the anisotropic behavior of the membrane, in which the strains and the stresses are calculated.

If one places oneself into nonlinear, as the membrane cannot have that an isotropic behavior the keyword will only be used to modify the reference mark of posting of the constraints.

/ AXIS = (vx, vy, vz)

Just like ANGL_REP, this keyword makes it possible to fix the local reference mark of the element. The projection of the vector indicated via the keyword AXIS the vector defines y room, whereas ANGL_REP determine the vector x room.

For example, in the case of a cylindrical geometry, it makes it possible to lay down the direction of the membranes in a circonférencielle way.

\diamond / N_INIT = / ninit [reality]
 / 0. [defect]

This keyword makes it possible to define an initial prevoltage allowing the convergence of calculation into nonlinear (it is thus useless into linear). It is applied only to the first step of time. It is expressed in unit of force per unit of length.

17 Keyword RIGI_PARASOL

17.1 Syntax

```

RIGI_PARASOL = _F (
  # Meshs being used to distribute the characteristics of the discrete
  ones
  ◆ GROUP_MA = l_gma, [l_group_ma]
  # Meshs of the type POI1 corresponding to the discrete ones
  ◇/GROUP_MA_POI1 = gmapoil, [group_ma]
  # Meshs of the type SEG2 corresponding to the discrete ones
  / GROUP_MA_SEG2 = l_gma, [l_group_ma]
  # Functions of distribution
  ◆/FONC_GROUP = l_fg, [l_fonction]
  / COEF_GROUP = l_cg, [l_réel]
  # total Stiffnesses to distribute
  ◆ CARA = /. |'K_TR_D_N'|' K_T_D_N'|
            |' K_TR_D_L'|' K_T_D_L'|
            / |'A_TR_D_N'|' A_T_D_N'|
            |' A_TR_D_L'|' A_T_D_L' [l_txm]
  ◆ VALE = l_val, [l_réel]
  ◇ REFERENCE MARK = ['LOCAL'|'TOTAL'], [defect]
  # Centers revolves
  ◆ GROUP_NO_CENTRE = gno, [group_no]
  / COOR_CENTRE = l_xyz, [l_réel]
  # EuroPlexus
  ◇ EUROPLEXUS = ['NOT'|' OUI'] [defect]
  # Output unit
  ◇ UNIT = links, [entirety]
),

```

17.2 Easily affected characteristics

This functionality corresponds to a methodology used to determine the characteristics of discrete elements (springs of translation and/or rotation) to apply to the nodes of a foundation raft starting from results got by the code PARASOL.

This option is available in 3D and 2D. In the case 3D the foundation raft will be modelled by a surface, in the case 2D it will be modelled by a line (test SSNL130 [V6.02.130]). In the case 2D the discrete ones are '2D_DIS_TR' or '2D_DIS_T'.

One must affect modeling 'DIS_TR' or 'DIS_T' in 3D, on the group of nodes which compose the foundation raft. The meshes which compose the foundation raft (pertaining to the groups l_gma) carry a modeling of plate (DKT, DST) or a modeling of face of 3D (test SDLS108 [V2.03.108]).

It is necessary to distinguish a group from meshes for the foundation raft, to declare behind the keyword GROUP_MA keyword factor RIGI_PARASOL, and a group of meshes with 1 node being based on the nodes of this foundation raft which it is necessary to model and declare in AFFE_MODELE in the form of specific meshes of type POI1. If the meshes are of type POI1, it should be indicated using the keyword GROUP_MA_POI1 keyword factor RIGI_PARASOL.

The use of specific meshes of type POI1 is necessary for the assignment of laws of behavior in the operators of nonlinear calculation.

17.3 Description of the operands

◆ GROUP_MA

List of the groups of meshes which compose the foundation raft.

◇ GROUP_MA_POI1

List of the groups of points including the nodes of the groups of meshes defined by GROUP_MA. That makes it possible to declare the nodes of a foundation defined by meshes like specific meshes POI1 in order to affect the characteristics to them RIGI_PARASOL. That makes it possible to affect to them materials or behaviors for the use of a nonlinear operator. If it is not present, the nodes are regarded as late meshes for a strictly linear study.

◆ FONC_GROUP / COEF_GROUP

List of functions or real coefficients. There are as many arguments in this list than there are groups of meshes which compose the foundation raft (definite under the keyword GROUP_MA). The functions must have as a X-coordinate the distance to the centre of gravity (keyword defined by GROUP_NO_CENTRE / COOR_CENTRE).

◆ CARA/VALE

Total stiffnesses of ground, resulting from the code PARASOL are provided by the user using the keywords CARA and VALE as for the discrete elements. One can also select the nature of the reference mark (total or local) in which one defines the characteristics of the springs (keyword REFERENCE MARK). Stiffnesses or the depreciation only defined in translation can also be distributed ($K_{T_D_N}$ or $A_{T_D_N}$, pas de stiffness in rotation), in this case it is only necessary to give 3 values behind $VALE = (k_x, k_y, k_z)$.

◆ /GROUP_NO_CENTRE = gno / COOR_CENTRE = l_xyz

To define the center of the foundation raft (calculated by the code PARASOL), one can is to give the coordinates (three realities given behind the keyword COOR_CENTRE), that is to say to give the name of a group containing one only node of the grid (keyword GROUP_NO_CENTRE).

◇ EUROPLEXUS

If this key word is YES, Code_Aster create a structure of data exploited by the macro order CALC_EUROPLEXUS. For more detail to see documentation associated with Europlexus and the case test PLEXU01A who implements this functionality.

◇ UNIT

If this key word is present, Code_Aster creates a file, corresponding to the number of unit, which contains the stiffnesses of discrete affected with the various nodes.

17.4 Principle of determination of the characteristics of the discrete elements

The document [R4.05.01] "Seismic answer by transitory analysis" give theoretical information about the method employed.

In 3D, the foundation raft is represented by a set of surface elements of centre of gravity O . Using the code PARASOL, one obtains 6 total sizes which characterize the coupling between the ground and the foundation raft: three stiffnesses of translation K_x, K_y, K_z and three stiffnesses of rotation Kr_x, Kr_y, Kr_z .

In each node of the grid of the foundation raft, Code_Aster seek the characteristics in stiffness of a discrete element of type $K_{TR_D_N}$ ($k_x, k_y, k_z, kr_x, kr_y, kr_z$) cf [R4.05.01].

To determine the stiffnesses of translation, one forces that they are proportional to the surface represented by the node and a function of distribution depending on the distance to the centre of

gravity of the foundation raft. That is to say $S(P)$ the surface attached to the node P and $f(r)$ the function of distribution where r is the distance from the node P with the node O .
For the stiffnesses of rotation, one distributes the remainder in the same way (what remains after having removed the contributions due to the translations) that the translations.

If one calculates the efforts and the moments resulting at the point O had with the distribution of the springs in each node of the grid of the foundation raft and if one identifies them with the values obtained by PARASOL, the following formulas are obtained:

$$k_x = K_x I \left(\sum_p S(p) f(op) \right) ; k_x(p) = k_x S(p) f(op)$$

$$k_y = K_y I \left(\sum_p S(p) f(op) \right) ; k_y(p) = k_y S(p) f(op)$$

$$k_z = K_z I \left(\sum_p S(p) f(op) \right) ; k_z(p) = k_z S(p) f(op)$$

$$k_{rx} = \left(K_{rx} - \sum_p (k_z(p) y_{op}^2 + k_y(p) z_{op}^2) \right) I \left(\sum_p S(p) f(op) \right) ; k_{rx}(p) = k_{rx} S(p) f(op)$$

$$k_{ry} = \left(K_{ry} - \sum_p (k_x(p) z_{op}^2 + k_z(p) x_{op}^2) \right) I \left(\sum_p S(p) f(op) \right) ; k_{ry}(p) = k_{ry} S(p) f(op)$$

$$k_{rz} = \left(K_{rz} - \sum_p (k_x(p) y_{op}^2 + k_y(p) x_{op}^2) \right) I \left(\sum_p S(p) f(op) \right) ; k_{rz}(p) = k_{rz} S(p) f(op)$$

If the key word INFORMATION = 2, the computed values above are written in the file MESSAGE with the format of the orders of Code_Aster.

Notice 1 :

Calculation of the area attached to the point P .

For each surface mesh of the foundation raft, one calculates surface, one divides it by the number of tops of the mesh and one affects this contribution to each node of the mesh. One

ensures then: $S_{radier} = \sum_p S(p)$.

Notice 2:

It is considered that one can apply the same formulas to carry out a distribution of discrete elements of damping.

17.5 Example of use

N°1 example

```
RIGI_PARASOL = _F (GROUP_MA = to erase, COEF_GROUP = 2. , NOEUD_CENTRE = 'P1',
```

```
  CARA = ('K_TR_D_N', 'A_TR_D_N'), VALE = (6 realities, 6 realities),)
```

N°2 example: INFORMATION = 2

```
RIGI_PARASOL = _F (GROUP_MA = 'DALLE', COEF_GROUP = 1.0, GROUP_NO_CENTRE = 'PCDG',
  GROUP_MA_POI1 = 'RESSORT', REPERE = 'GLOBAL',
  CARA = 'K_T_D_N', VALE = (10000.0, 10000.0, 10000.0),),)
```

An extract of posting in the output file:

```
PAS DE REPARTITION EN ROTATION POUR DES K_T_D_N
  _F (NOEUD = ' N1      ', CARA = ' K_T_D_N ',
    VALE = ( 1.56250E+02, 1.56250E+02, 1.56250E+02, ), REPERE = ' GLOBAL '),
  _F (NOEUD = ' N2      ', CARA = ' K_T_D_N ',
    VALE = ( 1.56250E+02, 1.56250E+02, 1.56250E+02, ), REPERE = ' GLOBAL '),
  _F (NOEUD = ' N3      ', CARA = ' K_T_D_N ',
```

VALE= (3.12500E+02, 3.12500E+02, 3.12500E+02,), REPERE=' GLOBAL'),

18 Keyword RIGI_MISS_3D

18.1 Syntax

```
RIGI_MISS_3D = _F (
  ♦ GROUP_MA_POI1      = l_gma,                [l_group_ma]
  ♦ GROUP_MA_SEG2     = l_gma,                [l_group_ma]
  ♦ FREQ_EXTR         = freq,                  [reality]
  ♦ UNITE_RESU_IMPE   = links (30),          [entirety (defect)]
)
```

18.2 Easily affected characteristics

The use of this keyword is dedicated to problems of separation of foundation in order to better take into account the carpet of springs of ground than does it RIGI_PARASOL who proportionally distributes 6 total stiffnesses under a foundation on the surfaces of the elements surrounding his nodes.

This keyword will affect the exact terms of a matrix of impedance calculated by MISS3D for all the degrees of freedom of interface (3 times the number of nodes) and for a frequency of extraction given. The assignment of these terms (modeling 'DIS_T') is done then with the specific meshes POI1 nodes of the surface foundation and possibly with the lines of the network of SEG2 superimposed with the foundation to represent the transverse connections between nodes.

18.3 Description of the operands

♦ GROUP_MA_POI1

Group of specific meshes of the nodes of the foundation.

◇ GROUP_MA_SEG2

Group of meshes of SEG2 connecting the nodes of the foundation transversely.

♦ FREQ_EXTR

Frequency of extraction of the matrix of impedance.

◇ UNITE_RESU_IMPE

Logical unit of the matrix of impedance calculated by CALC_MISS option FILE.

19 Keyword MASS_AJOU

19.1 Syntax

```
MASS_AJOU = _F (
  ♦ GROUP_MA           = gma,           [group_ma]
  ♦ GROUP_MA_POI1     = gma,           [group_ma]
  ♦ FONC_GROUP        = fg,           [function]
)
```

19.2 Easily affected characteristics

The objective this keyword is to take into account simply the added mass of fluid in the problems of stoppings without having to model the fluid as in `MACRO_MATR_AJOU` and to preserve only the structure for nonlinear dynamic studies.

The idea is thus, in a new option of `AFFE_CARA_ELEM`, to distribute characteristics of specific mass to the nodes of the interface fluid-structure of the face upstream without adding degrees of freedom apart from the structure.

One is inspired thus by the distribution by total characteristics by rigidity or damping by the option `RIGI_PARASOL` of `AFFE_CARA_ELEM`.

In this new option `MASS_AJOU`, one distributes with the nodes of the interface fluid-structure with characteristics 'M_T_N' elementary values of directional mass obtained by integration of the normal pressure to each element starting from functions of distribution of this normal pressure depending on the coordinates - in particular of altitude - in order to express relations of Westergaard for example or more simply the expression of the hydrostatic pressure.

The assignment of these terms (modeling to declare in `AFFE_MODELE` : 'DIS_T' for a surface interface fluid-structure in 3D and '2D_DIS_T' for a linear interface fluid-structure in 2D) is done then with the specific meshes `POI1` nodes of the interface fluid-structure using the keyword `GROUP_MA_POI1` keyword factor `MASS_AJOU`.

It is necessary to distinguish these specific meshes from groups of the surface or linear meshes for the interface fluid-structure, to declare behind the keyword `GROUP_MA`.

19.3 Description of the operands

♦ `GROUP_MA`

Group of surface meshes (in 3D) or linear (in 2D) of the interface fluid-structure.

♦ `GROUP_MA_POI1`

Group of specific meshes of the nodes of the interface fluid-structure.

♦ `FONC_GROUP`

Function of distribution of the normal pressure depending on the coordinates of the group of meshes composing the interface fluid-structure (definite under the keywords `GROUP_MA` or `GROUP_MA_POI1`). The function must be homogeneous with a surface density of mass.

20 Keyword MASS_REP

20.1 Syntax

```

MASS_REP = _F (
  # Surface or line being used to distribute the mass
  ♦ GROUP_MA          = gr_ma,                                [group_ma]
  # Meshs of the type POI1 corresponding to the masses
  ♦ GROUP_MA_POI1    = gr_poi1,                              [group_ma]
  # Masses to distribute on the meshes of GROUP_MA
  ♦ VALE              = mass,                                [reality]
  ♦ STANDARD          = ['SURFACE', 'LINEAR', 'TOTAL'],      [txt]
  # Function of distribution of the mass
  ◇ FONC_MULT        = fonction_mult,                        [function]
),

```

20.2 Easily affected characteristics

The objective this keyword is to take into account simply a mass and to distribute it on a surface. The option `MASS_REP`, allows to distribute with the nodes of discrete of characteristic 'M_T_D_N' values of mass obtained in proportion to the surface of the surface meshes or length of the linear meshes.

The assignment (modeling 'DIS_T' to declare in `AFFE_MODELE`) is done with the specific meshes `POI1` data with `GROUP_MA_POI1`. It is necessary to distinguish the specific meshes and the surface meshes to declare behind the keyword `GROUP_MA`.

The rule of overload applies [U1.03.00]. If a mesh POI1 is present in several occurrences of MASS_REP it is the last assignment which is taken into account.

In the event of overload information is written in the file of 'messages', indicating the number of overloads carried out.

20.3 Description of the operands

♦ `GROUP_MA`
Surface groups of meshes.

♦ `GROUP_MA_POI1`
Group of specific meshes, type 'DIS_T' to declare in `AFFE_MODELE`.

♦ `VALE = mass`
Value of the mass to be distributed for the surface concerned with `GROUP_MA`. Its unit is homogeneous with $surface^{-1}$, $longueur^{-1}$ according to the value of `TYPE`.

♦ `STANDARD = ['SURFACE', 'LINEAR', 'TOTAL']`
Allows to define the mass to be assigned to the discrete ones of type 'M_T_D_N'. This mass is function of the surface of the meshes which are connected to the node of the discrete one. One can give:

- one `MASS` of 'SURFACE' `TYPE=`: this mass is distributed in proportion to the surface of the surface meshes connected to the node of the discrete ones. Meshs of the type `POI1` are affected by the mass:

$$Masse_{POI1} = Masse_{Surfacique} * Surface_{Noeud}$$

- one `MASS` of 'LINEAR' `TYPE=`: this mass is distributed in proportion to the length of the linear meshes connected to the node of the discrete ones. Meshs of the type `POI1` are affected by the mass:

$$Masse_{POI1} = Masse_{Linéique} * Longueur_{Noeud}$$

- one `MASS` with 'TOTAL' `TYPE=`: it is the total mass to distribute either in proportion to the surface of the surface meshes or in proportion to the length of the linear meshes, connected to the node of the discrete ones. Meshs of the type `POI1` are affected by the mass:

$$Masse_{POII} = \frac{Masse_{Totale} * Surface_{Noeud}}{Surface_{Totale}} \text{ or } Masse_{POII} = \frac{Masse_{Totale} * Longueur_{Noeud}}{Longueur_{Totale}}$$

◇ FONC_MULT = fonction_mult

One can give a function (X, Y, Z) which multiplies the mass to distribute mesh. This function is evaluated in the centre of gravity of the mesh.